



221-412

CONTENT

Augmented Reality (AR) - Digital meets real	2
3D preview of 221-412	3
Integrate Wago catalog inside your CAD System	4
2D derivations and Bill-Of-Material (BOM)	5
Technical drawings	6
Technical data	7
Get a free E-Learning training for Wago catalog	8



221-412

AR

Augmented Reality, often shortened to AR, is a technology that blends digital information into the real world. For more information, please click [here](#) or directly try yourself by scanning the QR code with your phone.

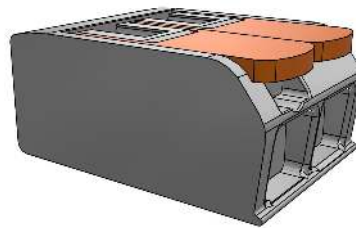

Please scan the QR code above and open on AR-enabled device.

There is a possibility that the configuration will fail. If that happens, please try a different product.



221-412

3D view

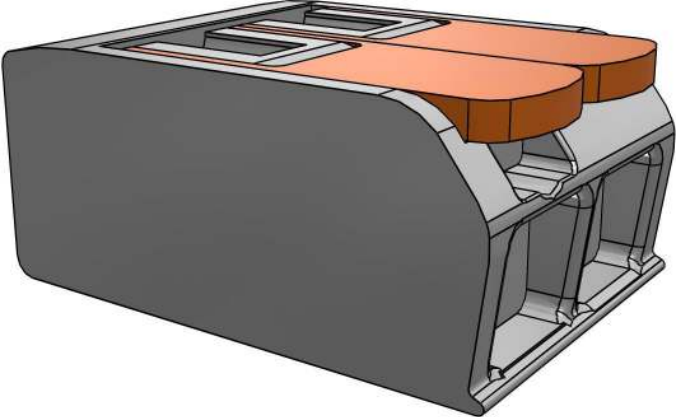

HOW TO ACTIVATE 3D?

To activate the interactive 3D view in Acrobat Reader, you need to select, at the top of the page, **Options** and then **Trust this document**

Zoom

Se mueve hacia objetos o se aleja de ellos en la pantalla cuando se mueve verticalmente. También puede hacer Zoom con la mano de las herramientas preseionando la recla Shift mientras arrastra

Pan

El modelo se puede mover solo horizontal o verticalmente. También puede girar con la mano de herramientas: Ctrl-arrastrar.

Girar

Gira objetos 3D relativos a la pantalla. Cómo los objetos se mueven depende de la vista de comienzo, donde usted empieza a arrastrar y en la dirección en la que usted arrastra.



221-412

CAD plugins

With our CAD integrations, you can use 3Dfindit directly in your CAD system and make your work easier with additional comfort functions, such as replacing a part and many more.



To the plugins



221-412

2D derivation

ISO view

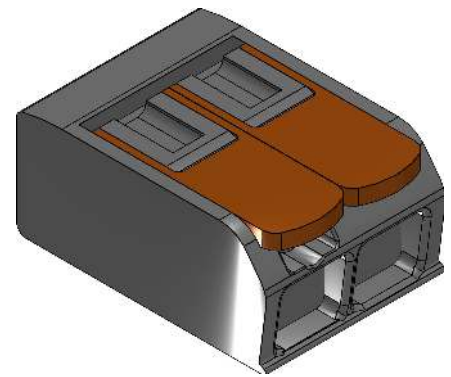
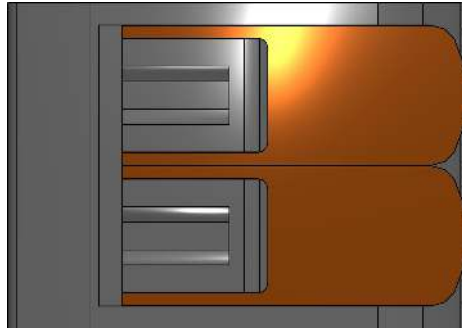
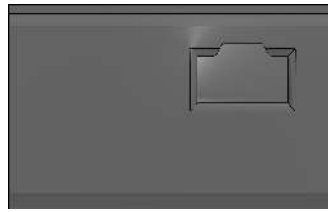
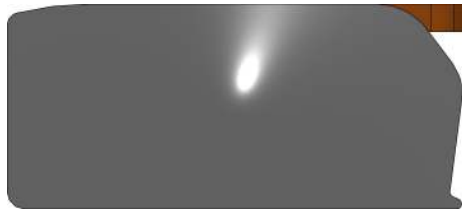

Bill-Of-Materials

N°	Designación	Cantidad
1.1	221-412	1



221-412

Technical drawings



221-412

Technical data

BESTNR (Item-No.)	221-412
INFODE (WAGO eShop)	Info DE
INFOEN (WAGO eShop)	Info EN
QUERSCHNITT1 (Sección / mm ²)	0.2 - 4 "e + m" / 0.14 - 4 "f"
QUERSCHNITT2 (Sección / AWG)	24 - 12
ABISOLIERLAENGE (Longitud de pelado / mm)	11
SPANNUNG (Tensión asignada según / V)	450
BEMESSSTOSSSPG (Tensión de choque asignada / kV)	4
VERSCHMUTZGRAD (Grado de ensuciamiento)	2
STROM (Intensidad de corriente según / A)	32
P (Número de polos)	2
HOEHE (Altura / mm)	8.15
BREITE (Ancho / mm)	13
TIEFE (Profundidad / mm)	18.3
ANZAHLKLEMMSTEL (Número de puntos de conexión)	2
ANZAHLPOTENTIAL (Número de potenciales)	2
FARBE (Color)	transparent
GEWICHT (Peso / g)	1.6
FILENAME (Filename)	221-412



221-412

E-Learning

Discover free training for 3Dfindit, the search engine for engineers, designers, and architects. Our 30 to 50-minute interactive courses provide you with comprehensive knowledge about the platform. Upon successful completion, you will receive a certificate. Start your first course now and master 3Dfindit!



Become an Expert of Digital Engineering

E-Learning
Get a free certificate!

Boost your career and get ready for Industry 4.0!

 **3Dfindit**

[Learn more](#)

[Start course](#)