

# HC-STA-B10PT-BWSC-LS-M25-ELCAL - Connector set



1416354

<https://www.phoenixcontact.com/us/products/1416354>

Please be informed that the data shown in this PDF document is generated from our online catalog. Please find the complete data in the user documentation. Our general terms of use for downloads are valid.

Connector set, number of positions: 10, connection method: Push-in connection, connection cross section: AWG 26- 14



## Commercial data

Item number	1416354
Packing unit	1 pc
Minimum order quantity	1 pc
Sales key	BF63
Product key	BF7AFX
Catalog page	Page 639 (C-2-2017)
GTIN	4055626071251
Weight per piece (including packing)	489.4 g
Weight per piece (excluding packing)	492.1 g
Customs tariff number	85366990
Country of origin	CN

# HC-STA-B10PT-BWSC-LS-M25-ELCAL - Connector set



1416354

<https://www.phoenixcontact.com/us/products/1416354>

## Set consists of

### HC-B10-I-PT-F - Contact insert

1407729

<https://www.phoenixcontact.com/us/products/1407729>

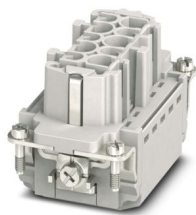

Contact insert, number of positions: 10+PE, size: B10, number of connections per position: 1, Socket, Push-in connection, 500 V, 16 A, 0.14 mm<sup>2</sup> ... 2.5 mm<sup>2</sup>, application: Power

---

### HC-B10-I-PT-M - Contact insert

1407730

<https://www.phoenixcontact.com/us/products/1407730>

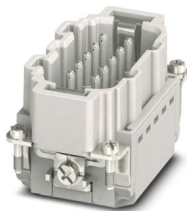

Contact insert, number of positions: 10+PE, size: B10, number of connections per position: 1, Pin, Push-in connection, 500 V, 16 A, 0.14 mm<sup>2</sup> ... 2.5 mm<sup>2</sup>, application: Power

# HC-STA-B10PT-BWSC-LS-M25-ELCAL - Connector set



1416354

<https://www.phoenixcontact.com/us/products/1416354>

## HC-STA-B10-BWSC-ELC-AL - Housing

1411321

<https://www.phoenixcontact.com/us/products/1411321>



Panel mounting base B10, with single locking latch, material: Die-cast aluminum, salt water resistant, protective cover material: PC, height: 30.5 mm, cable gland: none, protective cover: yes, Standard, with flat gasket

---

## HC-STA-B10-HLFS-1STM25-EL-AL - Housing

1412625

<https://www.phoenixcontact.com/us/products/1412625>



Sleeve housing B10, for single locking latch, material: Die-cast aluminum, salt water resistant, cable outlets: 1, lateral, 1x M25, height: 57 mm, cable gland: none, Standard

# HC-STA-B10PT-BWSC-LS-M25-ELCAL - Connector set



1416354

<https://www.phoenixcontact.com/us/products/1416354>

## G-INS-M25-M68N-NNES-S - Cable gland

1411165

<https://www.phoenixcontact.com/us/products/1411165>



Cable gland, material for screw connection: Brass, nickel-plated, application: Standard, external cable diameter 11 mm ... 17 mm, shielding: no, connecting thread: M25 x 1.5, color: silver, with O-ring

# HC-STA-B10PT-BWSC-LS-M25-ELCAL - Connector set



1416354

<https://www.phoenixcontact.com/us/products/1416354>

## Technical data

### Product properties

Product type	Connector set
Housing type	Complete housing
Series	HC-B
Application	Standard
Type	B10
Number of positions	10
Connection profile	10+PE
No. of cable outlets	1
Seal present	yes
Protective cover	yes

### Insulation characteristics

Overvoltage category	III
Degree of pollution	3

### Electrical properties

Rated voltage (III/3)	500 V
Rated surge voltage	6 kV
Rated current	16 A

### Connection data

Connection method	Push-in connection
Connection technology	Push-in connection
Conductor cross section	0.14 mm <sup>2</sup> ... 2.5 mm <sup>2</sup> (with ferrule) 0.14 mm <sup>2</sup> ... 2.5 mm <sup>2</sup> (with ferrule)
Connection cross section AWG	26 ... 14
Stripping length	8 mm ... 10 mm

### Dimensions

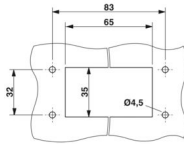
Dimensional drawing	
Width	53 mm
Height	87.5 mm
Length	93.5 mm
Drill hole distance, horizontal	83 mm
Drill hole distance, vertical	32 mm
Hole diameter	4.5 mm

# HC-STA-B10PT-BWSC-LS-M25-ELCAL - Connector set



1416354

<https://www.phoenixcontact.com/us/products/1416354>

## Installation dimensions

Width of the assembly cutout	35 mm
Length of the assembly cutout	65 mm

## Material specifications

Material Housing	Die-cast aluminum, saltwater-resistant
Material Protective cover	PA
Flammability rating according to UL 94	V0
Seal material Profile gasket	NBR
Seal material Flat gasket	NBR
Contact material	Copper alloy
Contact surface material	Ag
Contact carrier material	PC
Locking latch material	PA
Impact strength	IK08

## Cable/line

External cable diameter	11 mm ... 17 mm
	14 mm ... 17 mm (for UL 514 B)

## Mechanical properties

### Mechanical data

Locking type	Latch
Insertion/withdrawal cycles	≥ 500

## Environmental and real-life conditions

### Ambient conditions

Degree of protection	IP66
	IP67
Impact strength	IK08
Ambient temperature (operation)	-40 °C ... 100 °C

## Mounting

Mounting type	Screw mounting
Assembly instructions	Coding also using the CP-HC (1686478) coding profiles. HC-B6.. / HC-B10..for two coding profiles. HC-B16.. / HC-B24..for four coding profiles.
	Connectors may only be operated when there is no load/the power is switched off. Can be used for solid wires and stranded wires with ferrule.

# HC-STA-B10PT-BWSC-LS-M25-ELCAL - Connector set



1416354

<https://www.phoenixcontact.com/us/products/1416354>

## Drawings

Dimensional drawing

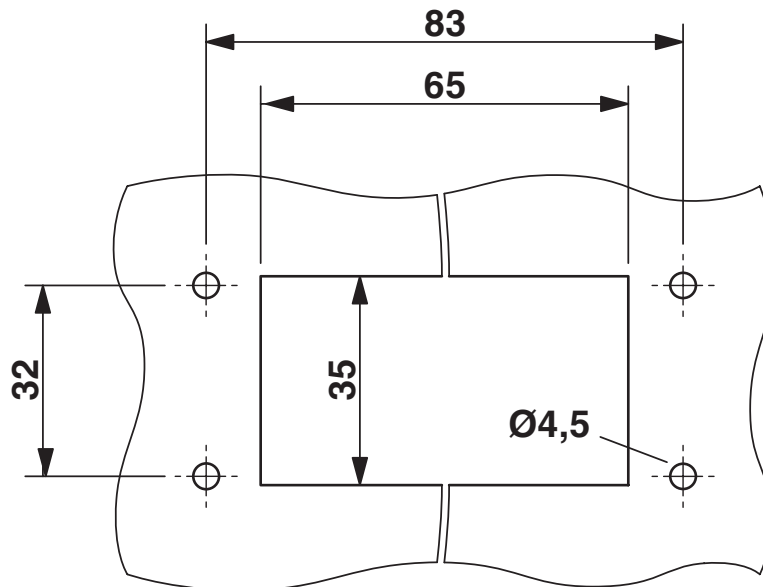

Mounting cutout

Dimensional drawing

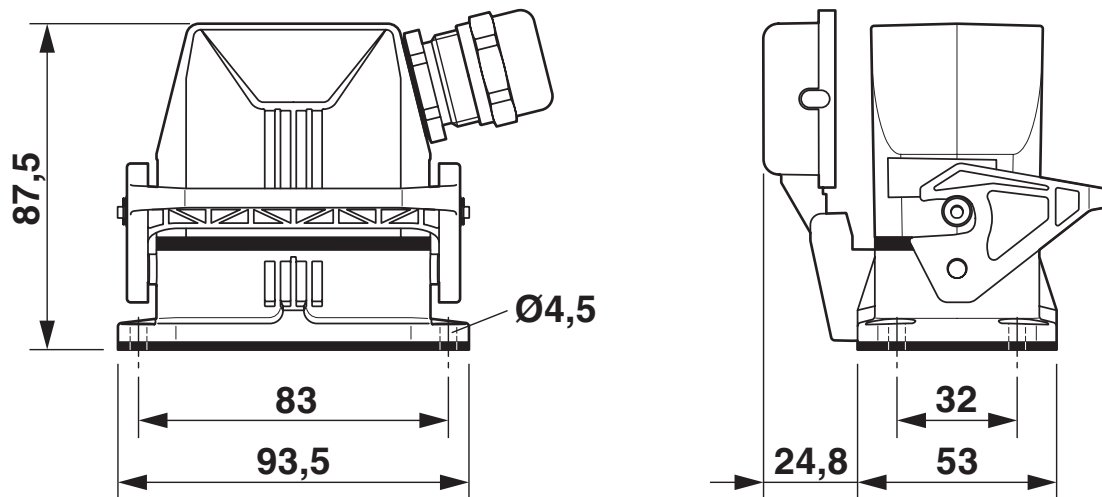

Dimensional drawing

# HC-STA-B10PT-BWSC-LS-M25-ELCAL - Connector set



1416354

<https://www.phoenixcontact.com/us/products/1416354>

## Schematic diagram

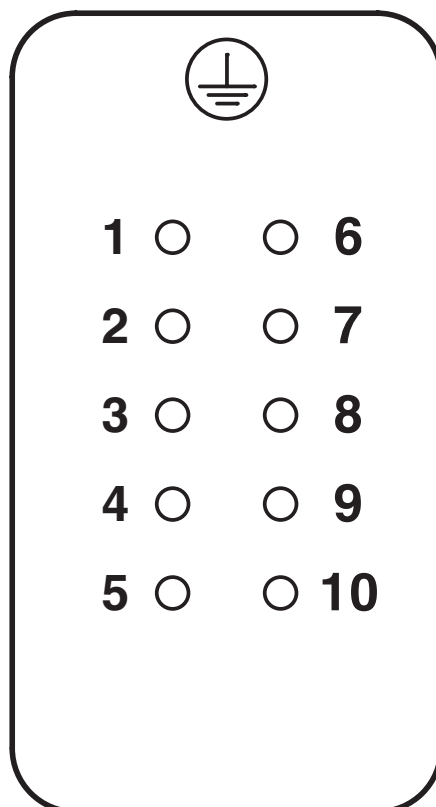

Pin assignment, connection side, socket



# HC-STA-B10PT-BWSC-LS-M25-ELCAL - Connector set

1416354

<https://www.phoenixcontact.com/us/products/1416354>

## Schematic diagram

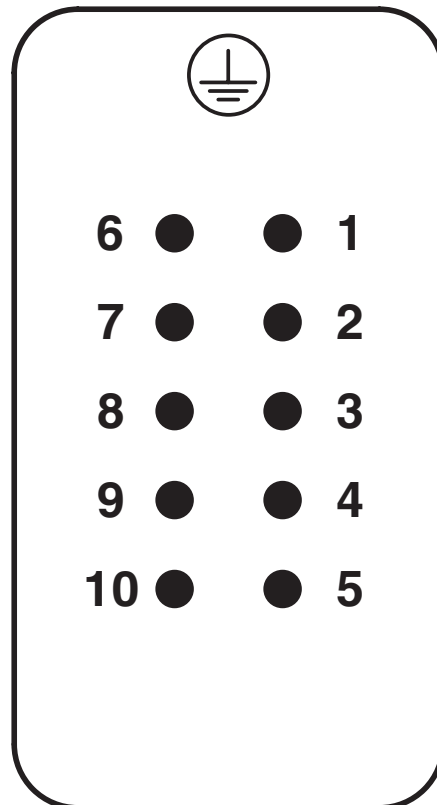

Pin assignment, connection side, pin

# HC-STA-B10PT-BWSC-LS-M25-ELCAL - Connector set



1416354

<https://www.phoenixcontact.com/us/products/1416354>

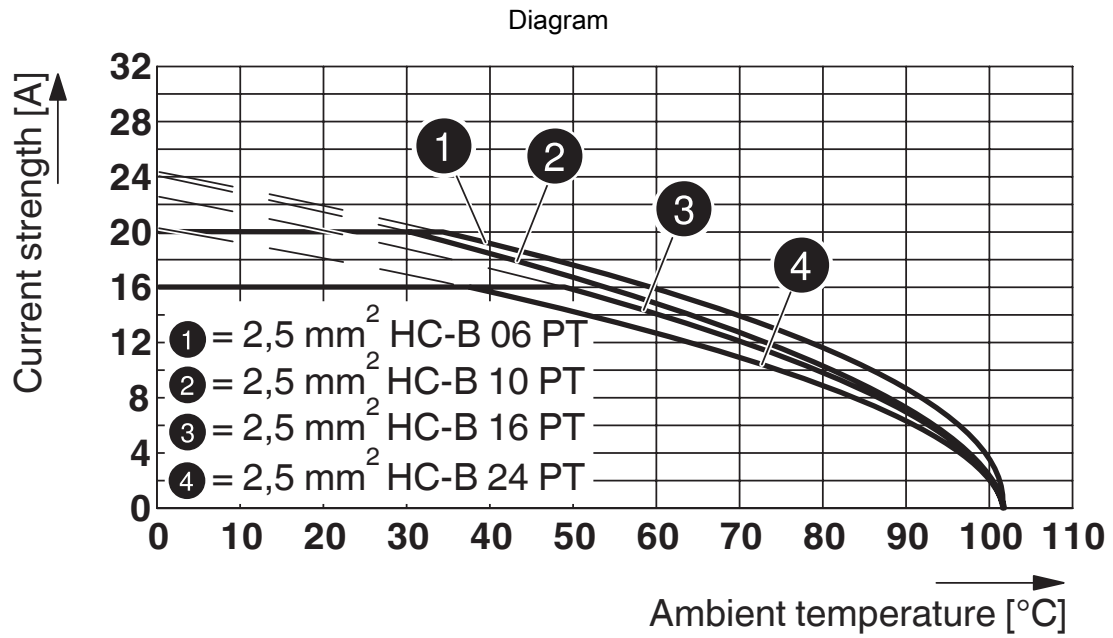

Derating diagram

# HC-STA-B10PT-BWSC-LS-M25-ELCAL - Connector set



1416354

<https://www.phoenixcontact.com/us/products/1416354>

## Approvals

To download certificates, visit the product detail page: <https://www.phoenixcontact.com/us/products/1416354>

**DNV**

Approval ID: TAE000037S



**EAC**

Approval ID: RU C-DE.AI30.B.01102



**EAC**

Approval ID: RU C-DE.BL08.B.00511

# HC-STA-B10PT-BWSC-LS-M25-ELCAL - Connector set



1416354

<https://www.phoenixcontact.com/us/products/1416354>

## Classifications

### ECLASS

ECLASS-11.0	27440101
ECLASS-12.0	27440113
ECLASS-13.0	27440113

### ETIM

ETIM 9.0	EC002636
----------	----------

### UNSPSC

UNSPSC 21.0	39121400
-------------	----------

# HC-STA-B10PT-BWSC-LS-M25-ELCAL - Connector set



1416354

<https://www.phoenixcontact.com/us/products/1416354>

## Environmental product compliance

### EU RoHS

Fulfills EU RoHS substance requirements	Yes
Exemption	6(c)

### China RoHS

Environment friendly use period (EFUP)	EFUP-50
	An article-related China RoHS declaration table can be found in the download area for the respective article under "Manufacturer declaration". For all articles with EFUP-E, no China RoHS declaration table issued and required.

### EU REACH SVHC

REACH candidate substance (CAS No.)	Lead(CAS: 7439-92-1)
SCIP	d3e5fa43-a8f1-41bf-9ee7-cf7e8bb18899

Phoenix Contact 2024 © - all rights reserved  
<https://www.phoenixcontact.com>

Phoenix Contact USA  
586 Fulling Mill Road  
Middletown, PA 17057, United States  
(+717) 944-1300  
[info@phoenixcon.com](mailto:info@phoenixcon.com)