

**DURABILITY**

**SAFETY**

**QUALITY**



**FUNCTIONALITY**

# The Worldwide Push Button Solution

Selection Guide

Bulletin 800F



**Allen-Bradley**

**Rockwell  
Automation**





# 800F

## Push Buttons

Allen-Bradley 22 mm 800F Push Buttons meet your specific push button needs.

- Superior Quality Design
- Product Flexibility
- Time and Cost Savings
- Aesthetic Appearance
- Worldwide Acceptability, Support and Delivery
- Reliable Application Solutions





# Superior Quality Design

The 800F line is designed and manufactured to meet demanding performance specifications. Using state-of-the-art solid modeling techniques and finite element analysis, each component built into 800F push buttons is optimized for durability and safe performance.

## Demanding Environments

Durable operator bushings and locking rings are constructed of die-cast zinc and finished with corrosion-resistant chromate plating.

## Corrosive Environments

Operator bushings and locking rings are constructed of industrial grade thermoplastic.

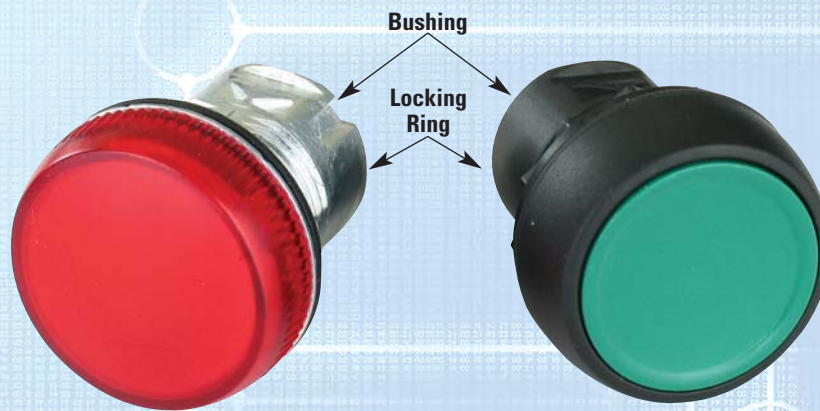

## Switching Safety

- Rigid teeth inside all 800F selector switches provide positive detent, which assures they will not hang-up between positions.
- Our constant energy solution adds an additional layer of protection to assure switching safety. Vibration or a slight bump will not cause a change in state.

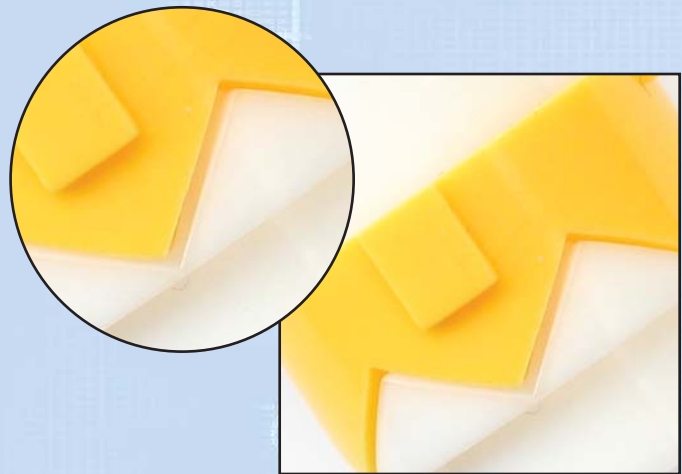



## Dependable Sealing

Dependable sealing offers IP65/66 and Type 4/13 ratings throughout the 800F product line.

### Diaphragm Seals

- Used throughout the 800F line on linear travel devices
- Flexes with the operation of the button
- Not dependent on lubrication for long life and performance

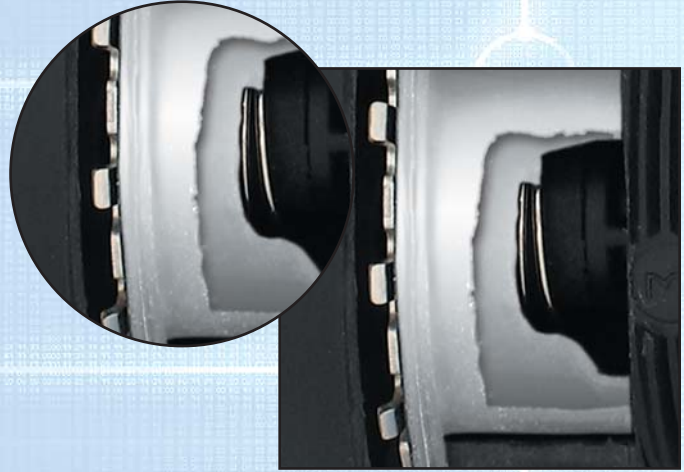

### K-Seals

- Used on rotating devices such as twist-to-release E-stops
- Dual wiping action provides high pressure sealing performance while lubrication trapping extends sealing life

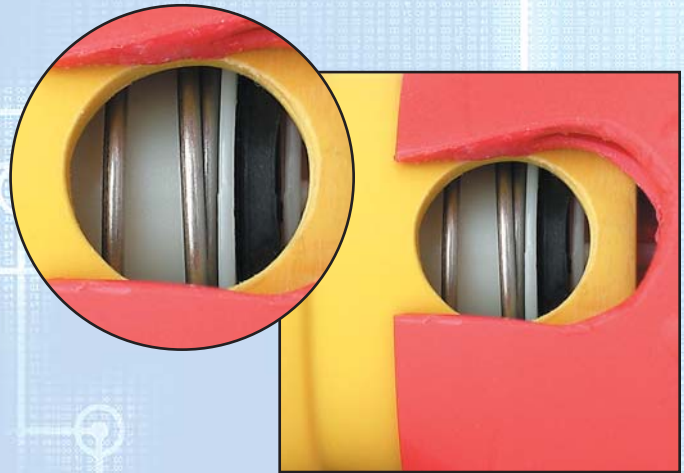

### Panel Gasket

- Installed on all devices
- Seals both panel and mounting hole for superior performance
- Provides operator retention for one-person installation





# Product Flexibility

## Modularity

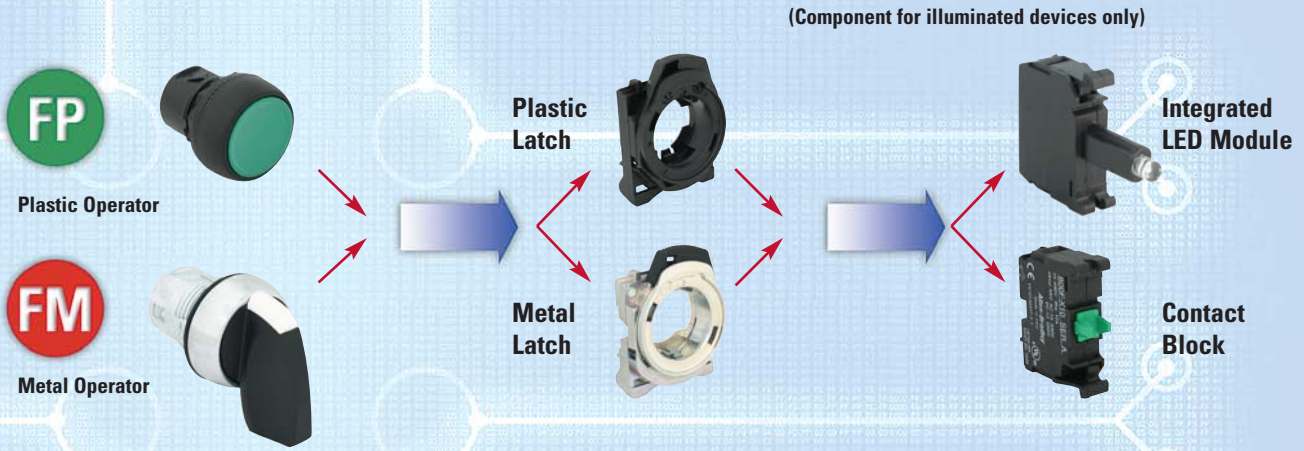

**Any Operator + Any Back Of Panel Component = Unparalleled Flexibility**

## Variety

The combinations of colors, styles and sizes in our operators are almost limitless and certain to meet any application requirement.





A variety of latch and contact block choices are available to fit both space and use requirements.



- Spring-clamp or screw terminations
- Single or dual circuit

- Rotating collar allows easy one-hand latch removal
- 30 x 40 mm (1-3/16" x 1-9/16") mounting matrix reduces panel space requirements
- Snap fit, tools not required to attach latch or contact blocks for ease of installation
- Bifurcated contact blocks provide excellent contact wiping and optimal switching reliability
- Color-coded contact block plungers for easy circuit identification

Choose from a large selection of illumination solutions to meet all your application needs. Integrated LED modules are available for all operators in 24V AC/DC, 120V AC and 240V AC. Power modules utilizing incandescent lamps are available for pilot lights, push buttons, and mushroom operators in 6V AC/DC-120V AC.

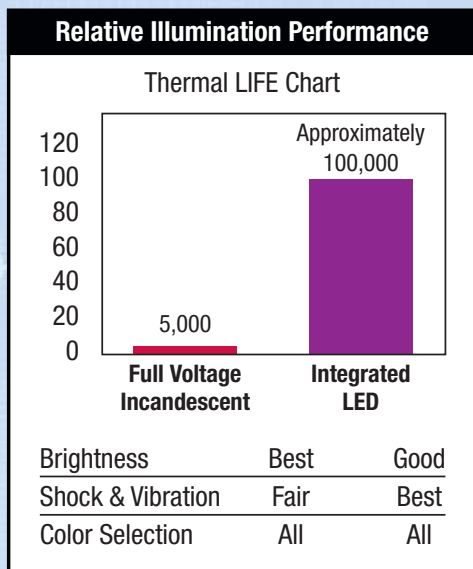



**A variety of accessories is offered ranging from legend plates, to replacement caps and lenses, to grounding kits and anti-rotation washers.**

### Legend Plates

- Two-piece style allows easy changing of legends, even after panel assembly
- One-piece style features low-tack adhesive to assist the installation process
- E-Stop legends come in two different sizes: 60 and 90 mm diameter
- International symbols, text, and custom markings are available

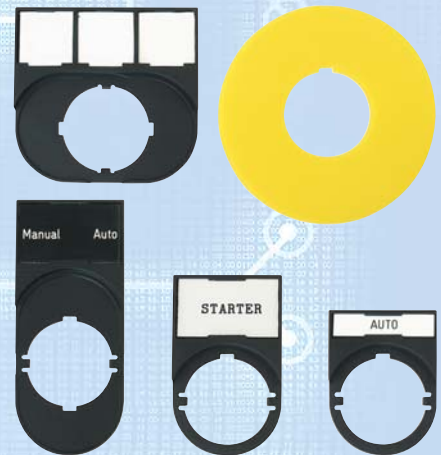

### Two-Color Plastic Caps and Custom Laser-Engraved Caps/Diffusers

- Saves space and simplifies installation by eliminating the need for separate legend plates
- Durable and long-lasting
- Laser engraving available for standard or custom text as well custom graphics on pushbutton caps, illuminated pushbutton diffusers, and pilot light diffusers



The 800F product line is completed with a full line of enclosures in both plastic and metal. Enclosures accept either latch or base-mounted contact blocks.



### Metal Enclosures

- 1-, 2-, 3-, and 5-hole configurations
- IP66 and Type 4/13 ratings
- PG or Metric through-holes
- Accepts two-piece snap-in legend

### Plastic Enclosures

- Available with PG or Metric knockouts enclosures
- IP66 and Type 4/4X/13 ratings
- 1-, 2-, 3-, 4-, and 6-hole configurations
- A 1-hole configuration is also available in yellow for E-stop applications
- Accepts two-piece snap-in legend



## Time and Cost Savings



Anti-rotation tab provides accurate alignment and eliminates operator and legend plate rotation. The tab is easily removed for use in panels without notches.

Rotating collar for easy assembly and removal.



Snap-down color-coded contact blocks.



Easy one-person mounting and removal provides both time and cost savings.

## Aesthetic Appearance

- Stylish appearance and lower front-of-panel profile designed to enhance equipment appearance
- Operators available with black plastic or shiny metal appearance

## Worldwide Acceptability, Support and Delivery

- Designed to meet worldwide standards
- UL Listed, CSA Certified, CE Marked, Third Party Approved: KEMA
- RoHs Directive (Restriction of Hazardous Substances) compliant
- Worldwide product manufacturing, configuration and distribution centers
- Worldwide product sales support









## Emergency Stops

### Reliability where it is needed most

When activated, E-Stops are designed to instantly cut off power to any operating equipment. Our E-Stops and contact blocks have been tested and certified by a European Testing Agency to meet the EN 418 and EN 60947-5-5 standards.



Additionally, our E-Stops provide the required anti-tease feature (Trigger action) that latches in the emergency stop command and then switches the contact state to open the circuit and shut down the equipment. E-Stops may be used with standard NC contact blocks, NCLB contact blocks, or Self-Monitoring contact blocks (SMCBs).







**Bulletin 800F Plastic and Metal Operators**

- 22.5 mm Mounting Hole
- IP65/66 Type 4/4X/13
- Internationally Rated Operators

**Table of Contents**

See below.

**TABLE OF CONTENTS**

Description	Page
<b>Specifications</b> .....	12
<b>Quick Selection</b> .....	15
<b>Push Buttons, Momentary</b>	
Non-Illuminated — Flush, Extended, Guarded .....	18
Non-Illuminated — with Two-Color Molded Legend Caps .....	19
Illuminated — Flush, Extended, Guarded .....	20
<b>Push Buttons, Alternate Action</b>	
Non-Illuminated — Flush .....	21
Illuminated — Flush .....	21
<b>Pilot Light Operators</b> .....	22
<b>Selector Switches</b>	
Non-Illuminated, 2-Position .....	23
Illuminated, 2-Position .....	24
Non-Illuminated, 3-Position .....	25
Illuminated, 3-Position .....	26
Non-Illuminated, 4-Position .....	27
<b>Key Selector Switches</b>	
2-Position .....	28
3-Position .....	29
<b>Emergency Stop Operators</b> .....	30
Twist-to-Release and Push-Pull Mushroom Operators	
Non-Illuminated .....	31
Illuminated .....	32
Key Release Mushroom Operators .....	33
Push-Pull Mushroom Operator, 3-Position .....	34
<b>Momentary Mushroom Operators</b>	
Non-Illuminated .....	35
Illuminated .....	36

Description	Page
<b>Multi-Function Operators</b>	
2-Function, Momentary, Non-Illuminated .....	37
2-Function, Momentary, Illuminated .....	38
3-Function, Momentary, Non-Illuminated .....	39
<b>Reset Operators</b> .....	40
<b>Single-Turn Potentiometer Assembly</b> .....	41
<b>Key Operated Selector Switch — SensEject™</b> .....	41
<b>Selector Push Button Operators</b> .....	42
<b>Toggle Switch Operators</b> .....	43
<b>Back-of-Panel Components</b>	
Contact Blocks .....	44
Power Modules .....	44
Power Modules with Contact Blocks .....	45
<b>Enclosures</b> .....	48
<b>Assembled Stations</b> .....	49
<b>Assembled Stations with DeviceNet</b> .....	50
<b>Pendant Stations</b> .....	51
<b>Accessories</b>	
Miscellaneous .....	52
Locking Attachments .....	55
Guards .....	56
Replacement Lamps .....	56
Caps, Diffusers, Lenses .....	57
Accessory Color Caps/Lenses/Diffusers without Text .....	57
Two-Color Molded Legend Caps .....	58
E-Stop Legends .....	58
Legend Plates .....	59
Custom Laser-Engraved Caps/Diffusers .....	60
Legend Text .....	61
<b>Approximate Dimensions</b> .....	64

**Bulletin 800FP Plastic Operators**

- Type 4/4X/13, IP65/66
- Engineering grade thermoplastics
- Chemical-resistant for harsh environments



800FP Plastic Operators



**Bulletin 800FM Metal Operators**

- Type 4/13, IP65/66
- Die-cast metal construction
- Chrome-plated



800FM Die-Cast Metal Operators



**Bulletin 800F**  
**22.5 mm Push Buttons**  
**Overview, Continued/Specifications**

**Overview, Continued**

**3-Across x 2-Deep Back-of-Panel (6 Circuits Maximum)**

- Rugged snap-fit design for plastic or metal latch
- Stackable contact blocks
- Rotating collar for easy one-hand latch removal
- Color-coded contact block plungers for contact identification

**Assembly Overview**

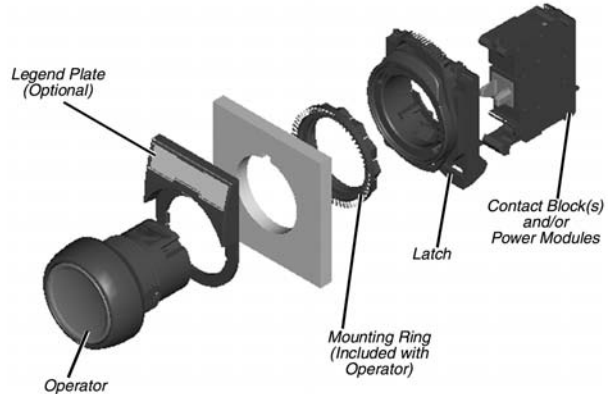
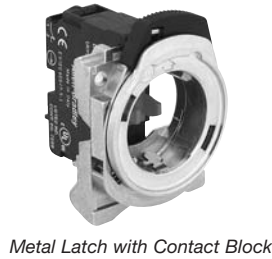

**Specifications\***

**Front-of-Panel (Operators)**

		Mechanical Ratings	
Description		Plastic (Bulletin 800FP)	Metal (Bulletin 800FM)
Vibration (assembled to panel)		Tested at 10...2000 Hz, 1.52 mm displacement (peak-to-peak) max./10 G max. for 3 hr duration, no damage	
Shock		Tested at 1/2 cycle sine wave for 11 ms; no damage at 100 G	
Degree of protection*		IP65/66 (Type 3/3R/4/4X/12/13)	IP65/66 (Type 3/3R/4/12/13)
Mechanical durability per EN 60947-5-1 (Annex C)	10,000,000 Cycles	Momentary Push Buttons, Momentary Mushroom	
	1,000,000 Cycles	Multi-Function, Selector Switch, Key Selector Switch, Selector Jog, SensEject™ Key Selector Switch	
	500,000 Cycles	Non-Illuminated Push-Pull E-Stop	
	300,000 Cycles	Twist-to-Release E-Stop, Illuminated Push-Pull E-Stop, Alternate Action Push Buttons	
	100,000 Cycles	Potentiometer, Toggle Switch	
Operating forces (typical with one contact block)		Flush/extended = 5 N, E-stop = 36 N Mushroom = 9 N	
Operating torque (typical application with one contact block)		Selector switch = 0.25 N•m (2.2 lb-in.)	
Mounting torque	Plastic	1.7 N•m (15 lb-in.)	
	Metal	4.4 N•m (40 lb-in.)	
Environmental			
Temperature range (operating)		-25...+70°C (-13...158°F)‡	
Temperature range (short term storage)		-40...+85°C (-40...185°F)	
Humidity		50...95% RH from 25...60°C (77...140°F)	

\* Performance Data — see page Important-2 of the Industrial Controls catalog (A115-CA001A-EN-P).

\* Momentary mushroom operators are IP65. Plastic keyed operators are IP66, Type 4/13; not Type 4X.

‡ Operating temperatures below 0°C (32°F) are based on the absence of freezing moisture and liquids, UL Recognized to 55°C (131°F) - Incandescent module Max 40°C (104°F).

**Product Certifications**

Certifications	UR/UL, CSA, CCC, CE
Conformity to Standards — CE marked	NEMA ICS-5; UL 508, EN 418, EN 60947-1, EN 60947-5-1, EN 60947-5-4, EN 60947-5-5
Terminal Identification	IEC 60947-1
Shipping Approvals	ABS
RoHS	✓



Electrical Ratings			
Standard contact block ratings		A600, Q600 600V AC AC 15, DC 13 to IEC/EN 60947-5-1 and UL 508, 17V, 5 mA min.	
Low voltage contact block ratings*		5V, 1 mA DC min. C300, R150, AC 15, DC 13 to EN 60947-5-1 and UL 508	
	Nominal Voltage	Range	Current Draw
LED Module Ratings	24V AC	10...29V AC	31 mA
	24V DC	10...30V DC	24 mA
	120V AC	70...132V AC	25 mA
	240V AC	180...264V AC	22 mA
Thermal current		10 A max. enclosed (40°C ambient) to UL508, EN 60947-5-1	
Insulation voltage (Ui)		Screw terminal = 690V, spring-clamp = 300V	
Wire capacity (screw terminal)‡		#18...12 AWG (0.75...2.5 mm <sup>2</sup> ) Max. (2) #14 AWG or (1) #12 AWG	
Wire capacity (spring-clamp terminal)		#18...14 AWG (0.75...1.5 mm <sup>2</sup> )	
Recommended tightening torque on screw terminals		0.7...0.9 N•m (6...8 lb-in.)	
Dielectric strength (minimum)		2500V for one minute	
External short circuit protection	Standard blocks	10 A type gL/gG cartridge fuse to EN 60269-2-1 or gN (Class J to UL 248-8 or Class C to UL 248-4)	
	Low voltage contact blocks	6 A type gL/gG cartridge fuse to EN 60269-2-1 or gN (Class J to UL 248-8 or Class C to UL 248-4)	
Electrical shock protection		Finger-safe conforming to IP2X	
Mechanical Ratings			
Vibration (assembled to panel)		Tested at 10...2000 Hz, 1.52 mm displacement (peak-to-peak) max./10 G max. 6 hr	
Shock		Tested at 1/2 cycle sine wave for 11 ms and no damage at 100 G max.	
Contact durability per EN 60947-5-1 (Annex C)		10,000,000 cycles	
Contact operation	N.O.	Slow double make and break	
	N.C.	Slow double make and break — positive opening ⊙	
	N.O.E.M.	Double break / double make, early make	
	N.C.L.B.	Double break / double make, late break — positive opening ⊙	
	N.C.E.B.	Double break / double make, early break — positive opening ⊙	
Push button travel to change electrical state	N.C. and N.O.E.M.	1.5 mm (0.060 in.)	
	N.O. and N.C.L.B.	2.5 mm (0.1 in.)	
Operating forces (typical)	Single circuit contact block	3.4 N	
	Dual circuit contact block	5...6.5 N	
Illumination			
LED Dominant Wavelength	Green	525 nm	
	Red	629 nm	
	Yellow	590 nm	
	Blue	470 nm	
	White	—	
LED Luminous Intensity	Green	890 mcd	
	Red	890 mcd	
	Yellow	690 mcd	
	Blue	193 mcd	
	White	412 mcd	
Incandescent maximum wattage		2.6 W	
Materials			
Springs		Stainless steel and zinc coated music wire	
Electrical contacts	Standard	Silver-nickel	
	Low voltage	Gold-plated over silver	
Terminals	Screw	Brass	
	Spring-clamp	Silver-plated brass	

\* Performance Data — see page Important-2 of the Industrial Controls catalog (A115-CA001A-EN-P).

\* Low voltage contacts are recommended for applications below 17V, 5 mA.

‡ Wires less than #18 (0.75 mm<sup>2</sup>) may not hold in terminal securely.









Bulletin 800F  
**22.5 mm Push Buttons**  
 Specifications, Continued

**Material Listing**

Component	For Use with	Material Used
Panel gasket	All operators	Nitrile, TPE
Diaphragm seal	Illuminated push button, non-illuminated push button	Automotive industry acceptable silicone
K-seal	Selector switch, key selector switch, push/twist-to-release E-stop, key E-stop, push/pull mushroom	Nitrile
Diaphragm retainer, return spring I	Illuminated push button, non-illuminated push button, momentary mushroom	Stainless steel
Return spring II	Reset, selector switch, key selector switch, alternate action, push/twist-to-release E-stop, key E-stop, push/pull mushroom	Zinc-coated music wire
Button cap/mushroom head	Non-illuminated push button, momentary mushroom, reset, push/twist-to-release E-stop, key E-stop, push/pull mushroom, multi-function	PBT/polycarbonate blend
2-color molded button cap	Non-illuminated push button	PBT/polycarbonate blend
Lens	Multi-function	Acetal
Lens, knob	Illuminated push button, illuminated momentary mushroom, illuminated selector switch	Polyamide
Knob	Non-illuminated selector switch	Glass-filled polyamide
Plastic bezel/bushing I	Non-illuminated push button, illuminated push button, momentary mushroom, selector switch, key selector switch, push/twist-to-release E-stop, key E-stop, push/pull mushroom, multi-function, reset	Glass-filled polyamide
Plastic bezel/bushing II, jam nut	Pilot light, reset jam nut, reset pushers	Glass-filled PBT
Metal bezel/bushing	All metal operators	Zinc
Diffuser	Illuminated push button, pilot light	Polycarbonate
Legend frames	—	Glass-filled polyamide
Plastic mounting ring	All plastic operators	Glass-filled polyamide
Metal mounting ring	All metal operators	Chromated zinc
Plastic latch	—	Glass-filled polyamide
Metal latch	—	Chromated zinc + stainless steel
Plastic enclosure	—	PBT/polycarbonate blend
Metal enclosure	—	Aluminum
Terminal screws	LED module, incandescent module, contact blocks	Zinc-plated steel with chromate
Terminals	LED module, incandescent module, contact blocks	Brass with silver-nickel contacts
Spring clamps	LED module, incandescent module, contact blocks	Stainless steel
Lamp socket	Incandescent module	Brass
Housing	Incandescent module, LED module	Glass-filled polyamide
Low-voltage terminals	Contact blocks	Gold-plated silver-nickel contacts
Low-voltage spanner	Contact blocks	Gold-plated silver-nickel contacts
Spanner	Contact blocks	Brass with silver-nickel contacts
Boot	Toggle Switch, illuminated push button, non-illuminated push button, multi-function illuminated and non-illuminated	Automotive industry acceptable silicone



Components

Operator Style	Description	Color	Construction	Cat. No.	Pkg. Quantity				
 Flush Operator, Cat. No. 800FP-F3	Non-Illuminated, Flush Push Button	Black	Plastic	800FP-F2	1				
	Non-Illuminated, Flush Push Button	Green		800FP-F3					
	Non-Illuminated, Extended Push Button	Red		800FP-E4					
	Non-Illuminated, Flush Push Button	Black	Metal	800FM-F2					
	Non-Illuminated, Flush Push Button	Green		800FM-F3					
	Non-Illuminated, Extended Push Button	Red		800FM-E4					
 Flush Operator, Cat. No. 800FM-LF4	Illuminated, Flush Push Button	Green	Plastic	800FP-LF3	1				
	Illuminated, Extended Push Button	Red		800FP-LE4					
	Illuminated, Flush Push Button	Yellow		800FP-LF5					
	Illuminated, Flush Push Button	Green	Metal	800FM-LF3					
	Illuminated, Extended Push Button	Red		800FM-LE4					
	Illuminated, Flush Push Button	Yellow		800FM-LF5					
 Diffused Pilot Light, Cat. No. 800FP-P7	Diffused Pilot Light	Green	Plastic	800FP-P3	1				
		Red		800FP-P4					
		Yellow		800FP-P5					
		Green	Metal	800FM-P3					
		Red		800FM-P4					
		Yellow		800FM-P5					
 Selector Switch, Cat. No. 800FP-SM32	Non-Illuminated, 2-Position, Maintained Selector Switch	Black	Plastic	800FP-SM22	1				
	Non-Illuminated, 3-Position, Maintained Selector Switch			800FP-SM32					
	Non-Illuminated, 3-Position, Spring Return from Both Positions Selector Switch			800FP-SB32					
	Non-Illuminated, 2-Position, Maintained Selector Switch		Metal	800FM-SM22					
	Non-Illuminated, 3-Position, Maintained Selector Switch			800FM-SM32					
	Non-Illuminated, 3-Position, Spring Return from Both Positions Selector Switch			800FM-SB32					
 40 mm Trigger Action Twist-to-Release Mushroom Cat. No. 800FP-MT44	Non-Illuminated, 40 mm Twist-to-Release Maintained Mushroom	Red	Plastic	800FP-MT44	1				
	Non-Illuminated, 40 mm Push-Pull Maintained Mushroom			800FP-MP44					
	Non-Illuminated, 40 mm Twist-to-Release Maintained Mushroom		Metal	800FM-MT44					
	Non-Illuminated, 40 mm Push-Pull Maintained Mushroom			800FM-MP44					
	<b>Back of Panel</b>			<b>Description</b>		<b>Cat. No.</b>	<b>Pkg. Quantity</b>		
	 Power Module with Latch Cat. No. 800F-MN3G			Metal Latch				800F-ALM	10
Plastic Latch				800F-ALP					
Normally Open Contact Block				800F-X10					
Normally Closed Contact Block				800F-X01					
Integrated LED Module with Plastic Latch — Red LED				800F-PNxR*	1				
Integrated LED Module with Plastic Latch — Green LED				800F-PNxG*					
Integrated LED Module with Plastic Latch — Yellow LED				800F-PNxY*					
Integrated LED Module with Metal Latch — Red LED				800F-MNxR*					
Integrated LED Module with Metal Latch — Green LED				800F-MNxG*					
Integrated LED Module with Metal Latch — Yellow LED				800F-MNxY*					



\* To complete the cat. no., replace the x with one of the following voltage codes: **3** = 24V, **5** = 120V, **7** = 240V.



Bulletin 800F  
**22.5 mm Push Buttons**  
 Quick Selection, Continued

Complete Units\*

Non-Illuminated Push Buttons, Momentary (Screw Terminal Connections)

	Description	Type of Contact		Color	Construction	Cat. No.	Pkg. Quantity
		N.O.	N.C.				
 Flush Operator, Cat. No. 800FP-F3PX10	Flush	1	—	Green	Plastic Operator / Plastic Latch	800FP-F3PX10	1
				Black		800FP-F2PX10	
				Green	Metal Operator / Metal Latch	800FM-F3MX10	
				Black		800FM-F2MX10	
 Cat. No. 800FM-E4MX01	Extended	—	1	Red	Plastic Operator / Plastic Latch	800FP-E4PX01	1
					Metal Operator / Metal Latch	800FM-E4MX01	
 Cat. No. 800FP-U2E4F3PX10	Multi-Function (Flush / Extended)	1	1	Green/Red	Plastic Operator / Plastic Latch	800FP-U2E4F3PX11	1
					Metal Operator / Metal Latch	800FM-U2E4F3MX11	
				Green "1" / Red "0"	Plastic Operator / Plastic Latch	800FP-U2EFFEPX11	
					Metal Operator / Metal Latch	800FM-U2EFFEMX11	

Non-Illuminated Selector Switches (Screw Terminal Connections)

	Description	Type of Contact		Style	Construction	Cat. No.	Pkg. Quantity
		N.O.	N.C.				
 Cat. No. 800FP-SM22PX10	Standard Lever, Black	1	—	2-position maintained	Plastic Operator / Plastic Latch	800FP-SM22PX10	1
		1	1	2-position maintained	Plastic Operator / Plastic Latch	800FP-SM22PX11	
		1	—	2-position maintained	Metal Operator / Metal Latch	800FM-SM22MX10	
		1	1	2-position maintained	Metal Operator / Metal Latch	800FM-SM22MX11	
		2	—	3-position maintained	Plastic Operator / Plastic Latch	800FP-SM32PX20	
		2	—	3-position maintained	Metal Operator / Metal Latch	800FM-SM32MX20	

\* For complete units not listed and configuration assistance, see RAISE product selection software (<http://www.ab.com/raise>).

Complete Units, Continued\*

Non-Illuminated Emergency Stop Operators, Ø 40 mm, Red (Screw Terminal Connections)

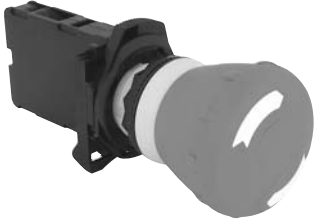
	Description	Type of Contact*		Construction	Cat. No.	Pkg. Quantity
		N.O.	N.C.			
 Cat. No. 800FP-MT44PX01S	Twist-to-Release	—	1	Plastic Operator / Plastic Latch	800FP-MT44PX01S	1
		—	1	Metal Operator / Metal Latch	800FM-MT44MX01S	
		1	1	Plastic Operator / Plastic Latch	800FP-MT44PX11S	
		1	1	Metal Operator / Metal Latch	800FM-MT44MX11S	

\* Self-monitoring contact block included when N.C. is specified.

Pilot Lights with Integrated LED Modules (Screw Terminal Connections)

	Voltage	Style	Construction	Cat. No.	Pkg. Quantity
 Cat. No. 800FP-P7PN3W	24V AC/DC	Green	Plastic Operator / Plastic Latch	800FP-P3PN3G	1
		Red		800FP-P4PN3R	
		Yellow		800FP-P5PN3Y	
		Blue		800FP-P6PN3B	
		White		800FP-P7PN3W	
	120V AC	Green		800FP-P3PN5G	
		Red		800FP-P4PN5R	
		Yellow		800FP-P5PN5Y	
		Blue		800FP-P6PN5B	
		White		800FP-P7PN5W	
	240V AC	Green		800FP-P3PN7G	
		Red		800FP-P4PN7R	
		Yellow		800FP-P5PN7Y	
		Blue		800FP-P6PN7B	
		White		800FP-P7PN7W	

\* For complete units not listed and configuration assistance, see RAISE product selection software (<http://www.ab.com/raise>).



Bulletin 800F  
**22.5 mm Push Buttons**  
 Product Selection

Momentary Push Button Operators, Non-Illuminated — Flush, Extended, Guarded



Flush Operator  
 Cat. No. 800FP-F3



Extended Operator  
 Cat. No. 800FM-E4



Guarded Operator  
 Cat. No. 800FP-G6

Color	Flush		Extended		Pkg. Quantity
	Plastic	Metal	Plastic	Metal	
	Cat. No.	Cat. No.	Cat. No.	Cat. No.	
Black	800FP-F2	800FM-F2	800FP-E2	800FM-E2	1
Green	800FP-F3	800FM-F3	800FP-E3	800FM-E3	
Red	800FP-F4	800FM-F4	800FP-E4	800FM-E4	

800F **P** - **F** **3** -       
           a      b      c      d

a

Operator Construction	
Code	Description
P	Round plastic operator (IP66, Type 4/4X/13)
M	Round metal operator (IP66, Type 4/13)

b

Operator Type	
Code	Description
F	Flush
E	Extended
G	Guarded

c

Color Cap	
Code	Color
0	Orange
1	White
2	Black
3	Green
4	Red
5	Yellow
6	Blue
8	Gray*
9	No cap
X	Assortment pack*

d

Packaging	
Code	Description
Blank	1 per package
BP	10 per package

\* Available in flush only.

\* Assortment pack contains one cap of each color, not available in BP packaging.

Momentary Push Button Operators, Non-Illuminated — with Two-Color Molded Legend Caps



Flush Operator  
 Cat. No. 800FP-F301

Button Color	Text Color	Legend Text	Flush		Extended		Pkg. Quantity
			Plastic	Metal	Plastic	Metal	
			Cat. No.	Cat. No.	Cat. No.	Cat. No.	
Green	White	START	800FP-F301	800FM-F301	-	-	1
		I	800FP-F306	800FM-F306	-	-	
Red	White	STOP	800FP-F402	800FM-F402	800FP-E402	800FM-E402	
		O	-	-	800FP-E405	800FM-E405	
Black	White	→	800FP-F208	800FM-F208	800FP-E208	800FM-E208	

800F **P** - **F** **3** **01** -       
                   a      b      c      d      e

**a**

Operator Construction	
Code	Description
P	Round plastic operator (IP66, Type 4/4X/13)
M	Round metal operator (IP66, Type 4/13)

**c**

Color Cap	
Code	Color
0	Orange
1	White
2	Black
3	Green
4	Red
5	Yellow
6	Blue

**d**

Legend Text**‡§	
Code	Text
01	START
02	STOP
05	O
06	I
08	→
09	Forward*
10	Reverse*
11	R

**b**

Operator Type	
Code	Description
F	Flush
E	Extended
G	Guarded

**e**

Packaging	
Code	Description
Blank	1 per package
BP	10 per package

\* For custom laser-engraved legend cap, order “no cap” option on page 18 plus custom laser-engraved cap on page 60.  
 \*\* White and yellow caps have black text. All other color caps have white text.  
 ‡ Valid color cap/legend text codes include:

Color	Text	
	Flush Caps	Extended Caps
White	FORWARD, REVERSE, START, I, →, R	→, R
Black	FORWARD, REVERSE, →, R	STOP, O, →, R
Green	FORWARD, REVERSE, START, I, →	→
Red	FORWARD, REVERSE, STOP, O, →	STOP, O, →
Yellow	FORWARD, REVERSE, →	→
Blue	FORWARD, REVERSE, →, R	→, R

§ Legend button cap supplied loose for customer installation.  
 \* Available for flush only.



Bulletin 800F  
**22.5 mm Push Buttons**  
 Product Selection, Continued

Momentary Push Button Operators, Illuminated — Flush, Extended, Guarded



Flush Operator  
 Cat. No. 800FM-LF4



Extended Operator  
 Cat. No. 800FP-LE3



Guarded Operator  
 Cat. No. 800FP-LG3

Color	Flush		Extended		Pkg. Quantity
	Plastic	Metal	Plastic	Metal	
	Cat. No.	Cat. No.	Cat. No.	Cat. No.	
Green	800FP-LF3	800FM-LF3	800FP-LE3	800FM-LE3	1
Red	800FP-LF4	800FM-LF4	800FP-LE4	800FM-LE4	
Yellow	800FP-LF5	800FM-LF5	800FP-LE5	800FM-LE5	
Clear	800FP-LF7	800FM-LF7	800FP-LE7	800FM-LE7	

800F **P** - **LE** **3** -       
           a      b      c      d

**a**

Operator Construction	
Code	Description
P	Round plastic operator (IP66, Type 4/4X/13)
M	Round metal operator (IP66, Type 4/13)

**c**

Color Cap *	
Code	Color
0	Amber
3	Green
4	Red
5	Yellow
6	Blue
7	Clear
9	No lens

**d**

Packaging	
Code	Description
Blank	1 per package
BP	10 per package

**b**

Operator Type	
Code	Description
LF	Flush
LE	Extended
LG	Guarded

\* For custom laser-engraved operator, order operator with applicable lens cap color plus custom laser-engraved diffuser page 60.

Push-to-Test Push Button Device Schematic

Illuminated push buttons may be wired as a push-to-test device by using the following schematic.

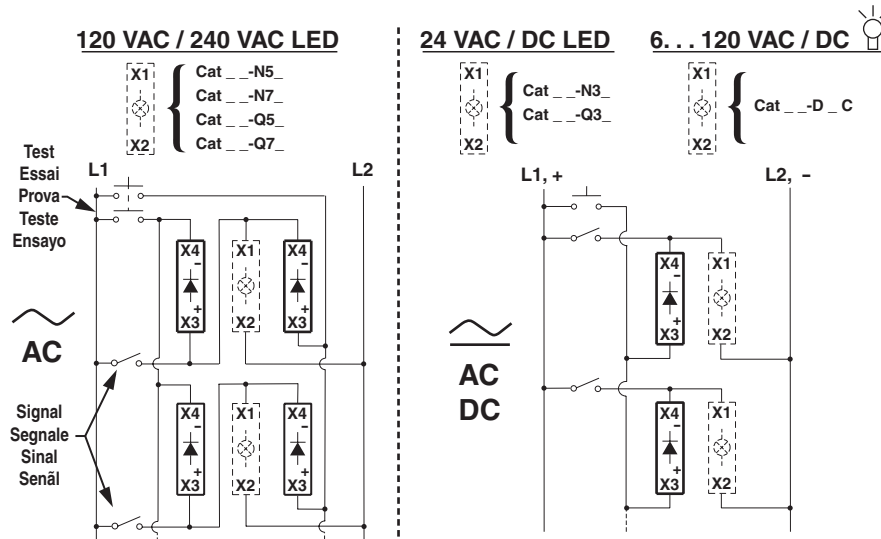

Alternate Action Operators — Non-Illuminated



800F **M** - **FA** **3**  
*a* *b* *c*

*a*

Operator Construction	
Code	Description
P	Round plastic operator (IP66, Type 4/4X/13)
M	Round metal operator (IP66, Type 4/13)

*b*

Operator Type*	
Code	Description
FA	Non-illuminated, Flush, Alternate Action

*c*

Color Cap*	
Code	Color
0	Orange
1	White
2	Black
3	Green
4	Red
5	Yellow
6	Blue
9	No cap
X	Assortment pack

\* Must use N.O.E.M. or N.C. Contacts.  
 \* For custom laser-engraved legend cap, order "no cap" option plus custom laser-engraved cap on page 60.

Alternate Action Operators — Illuminated



800F **P** - **LFA** **3**  
*a* *b* *c*

*a*

Operator Construction	
Code	Description
P	Round plastic operator (IP66, Type 4/4X/13)
M	Round metal operator (IP66, Type 4/13)

*b*

Operator Type§*	
Code	Description
LFA	Illuminated, Flush, Alternate Action

*c*

Color Cap>	
Code	Color
0	Amber
3	Green
4	Red
5	Yellow
6	Blue
7	Clear
9	No lens

§ Must use N.O.E.M. or N.C. Contacts.  
 \* LED module required for illumination, can not use incandescent module.  
 > For custom laser-engraved operator, order operator with applicable lens cap color plus custom laser-engraved diffuser on page 60.



Bulletin 800F  
**22.5 mm Push Buttons**  
 Product Selection, Continued

Pilot Light Operators\*



Plastic Pilot Light  
 Cat. No. 800FP-P7



Metal Pilot Light  
 Cat. No. 800FM-P4

Color	Plastic	Metal	Pkg. Quantity
	Cat. No.	Cat. No.	
Green	800FP-P3	800FM-P3	1
Red	800FP-P4	800FM-P4	
Yellow	800FP-P5	800FM-P5	

800F **P** - **P** **3** -       
           *a*    *b*    *c*    *d*

*a*

Operator Construction	
Code	Description
P	Round plastic operator (IP66, Type 4/4X/13)
M	Round metal operator (IP66, Type 4/13)

*b*

Operator Type	
Code	Description
P	Diffuser

*c*

Color Cap*	
Code	Color
0	Amber
3	Green
4	Red
5	Yellow
6	Blue
7	Clear
9	No lens

*d*

Packaging	
Code	Description
Blank	1 per package
BP	10 per package

\* For custom laser-engraved pilot light, order pilot light with applicable lens cap color plus custom laser-engraved diffuser on page 60.

2-Position Selector Switch Operators, Non-Illuminated



Standard Knob  
 Cat. No. 800FP-SM22



Knob Lever  
 Cat. No. 800FP-HM22

Switching Angle



Target Table and Operator Position*		
Contact Type§		
N.O.	O	X
N.C.	X	O

Note: X = Closed/O = Open  
 § Contact selection is limited to the following options, consult your Rockwell Automation distributor for other options.

Color	Operator Type		Standard Knob		Pkg. Quantity
			Plastic Cat. No.	Metal Cat. No.	
Black with White Insert	∨		800FP-SM22	800FM-SM22	1

\* Target table for spring return from left is reversed from what is shown in the table.

800F **P** - **S** **M2** **2** - -  
 a b c d e f

**a**

Operator Construction	
Code	Description
P	Round plastic operator (IP66, Type 4/4X/13)
M	Round metal operator (IP66, Type 4/13)

**b**

Operator Type	
Code	Description
S	Standard knob
H	Knob lever*

**c**

Operator Function	
Code	Type
M2	Maintained (60° switching angle) 
L2	Spring return from left (60° switching angle) 
R2	Spring return from right (60° switching angle) 

**e**

Orientation	
Code	Description
Blank	Standard
N	90° offset†

**f**

Packaging	
Code	Description
Blank	1 per package
BP	10 per package

**d**

Knob/Insert Color		
Code	Knob Color	Insert Color
2	Black	White

\* 30 mm hole spacing will not work if knob lever is used. See page 64 for recommended operator panel spacing.  
 † For use in vertical mount 800F enclosures.



Bulletin 800F  
**22.5 mm Push Buttons**  
 Product Selection, Continued

2-Position Selector Switch Operators, Illuminated



Standard Knob§  
 Cat. No. 800FP-LSM26

Switching Angle



Target Table and Operator Position*		
Contact Type➤		
N.O.	O	X
N.C.	X	O

**Note:** X = Closed/O = Open  
 ➤ Contact selection is limited to the following options, consult your Rockwell Automation distributor for other options.

Color	Operator Type		Standard Knob		Pkg. Quantity
			Plastic Cat. No.	Metal Cat. No.	
Green	✓	✓	800FP-LSM23	800FM-LSM23	1
Red	✓	✓	800FP-LSM24	800FM-LSM24	
Yellow	✓	✓	800FP-LSM25	800FM-LSM25	

\* Target table for spring return from left is reversed from what is shown in the table.

**800F** **P** - **LS** **M2** **3** - - -  
 a b c d e f

**a**

Operator Construction	
Code	Description*
P	Round plastic operator (IP66, Type 4/4X/13)
M	Round metal operator (IP66, Type 4/13)

**b**

Operator Type	
Code	Description
LS	Standard knob
LH	Knob lever♣

**c**

Operator Function	
Code	Type
M2	Maintained (60° switching angle) 
L2	Spring return from left (60° switching angle) 
R2	Spring return from right (60° switching angle) 

**e**

Orientation	
Code	Description
Blank	Standard
N	90° offset‡

**f**

Packaging	
Code	Description
Blank	1 per package
BP	10 per package

\* LED module required for illumination, can not use incandescent module.

‡ For use in vertical mount enclosures.

§ Crevices may exist on product that may be unsuitable for certain applications. Please consult your local Rockwell Automation distributor.

♣ Only available in clear.

**d**

Knob/Insert Color		
Code	Knob Color	Insert Color
0	Amber	White
3	Green	White
4	Red	White
5	Yellow	Black
6	Blue	White
7	Clear	Black

**3-Position Selector Switch Operators, Non-Illuminated**



Standard Knob  
 Cat. No. 800FP-SM32



Knob Lever  
 Cat. No. 800FM-HM32

**Switching Angle**

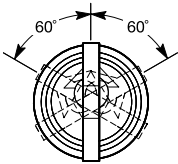

Target Table and Operator Position (60° Switching Angle)				
Contact Type*	Position on Mounting Latch			
N.O.	Left	X	O	O
	Right	O	O	X
	Center	X	O	X
	Center CL‡	X	O	O
	Center CR‡	O	O	X
N.C.	Left	O	X	X
	Right	X	X	O
	Center	O	X	O
	Center CL‡	O	X	X
	Center CR‡	X	X	O

**Note:** X = Closed/O = Open  
 \* Contact selection is limited to the following options, consult your Rockwell Automation distributor for other options.

Color	Operator Type 	Standard Knob		Knob Lever		Pkg. Quantity
		Plastic Cat. No.	Metal Cat. No.	Plastic Cat. No.	Metal Cat. No.	
Black with White Insert		800FP-SM32	800FM-SM32	800FP-HM32	800FM-HM32	1
		800FP-SB32	800FM-SB32	800FP-HB32	800FM-HB32	

**800F** **P** - **S** **M3** **2** - - -  
 a b c d e f g

**a**

Operator Construction	
Code	Description
P	Round plastic operator (IP66, Type 4/4X/13)
M	Round metal operator (IP66, Type 4/13)

**b**

Operator Type	
Code	Description
S	Standard knob
H	Knob lever*

**c**

Operator Function	
Code	Type
M3	Maintained 
L3	Spring return from left 
R3	Spring return from right 
B3	Spring return from left and right 

**d**

Knob/Insert Color		
Code	Knob Color	Insert Color
2	Black	White

**e**

Orientation	
Code	Description
Blank	Standard
N	90° offset*

**f**

Operation	
Code	Description
Blank	Standard
CL	Center Left‡
CR	Center Right‡

**g**

Packaging	
Code	Description
Blank	1 per package
BP	10 per package

\* 30 mm hole spacing will not work if knob lever is used. See page 64 for recommended operator panel spacing.  
 \* For use in vertical mount enclosures.  
 ‡ The center contact block can have the same target output as the left or right contact block, by specifying CenterLeft (CL) or CenterRight (CR) option.



Bulletin 800F  
**22.5 mm Push Buttons**  
 Product Selection, Continued

3-Position Selector Switch Operators, Illuminated



Standard Knob‡  
 Cat. No. 800FP-LSM37

Switching Angle

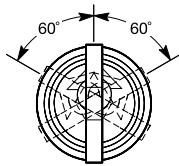

Target Table and Operator Position (60° Switching Angle)				
Contact Type*	Position on Mounting Latch			
N.O.	Left	X	O	O
	Right	O	O	X
N.C.	Left	O	X	X
	Right	X	X	O

Note: X = Closed/O = Open

\*Contact selection is limited to the following options, consult your Rockwell Automation distributor for other options.

Operator Type	Green		Red		Yellow		Pkg. Quantity
	Plastic Cat. No.	Metal Cat. No.	Plastic Cat. No.	Metal Cat. No.	Plastic Cat. No.	Metal Cat. No.	
	800FP-LSM33	800FM-LSM33	800FP-LSM34	800FM-LSM34	800FP-LSM35	800FM-LSM35	1
	800FP-LSR33	800FM-LSR33	800FP-LSR34	800FM-LSR34	800FP-LSR35	800FM-LSR35	
	800FP-LSL33	800FM-LSL33	800FP-LSL34	800FM-LSL34	800FP-LSL35	800FM-LSL35	
	800FP-LSB33	800FM-LSB33	800FP-LSB34	800FM-LSB34	800FP-LSB35	800FM-LSB35	

800F **P** - **LS** **M3** **3** - -  
 a b c d e f

**a**

Operator Construction	
Code	Description*
P	Round plastic operator (IP66, Type 4/4X/13)
M	Round metal operator (IP66, Type 4/13)

**b**

Operator Type	
Code	Description
LS	Standard knob
LH	Knob lever§

**c**

Operator Function	
Code	Type
M3	Maintained
L3	Spring return from left
R3	Spring return from right
B3	Spring return from left and right

**d**

Knob/Insert Color		
Code	Knob Color	Insert Color
0	Amber	White
3	Green	White
4	Red	White
5	Yellow	Black
6	Blue	White
7	Clear	Black

**e**

Orientation	
Code	Description
Blank	Standard
N	90° offset*

**f**

Packaging	
Code	Description
Blank	1 per package
BP	10 per package

\* LED module required for illumination, can not use incandescent module.

\* For use in vertical mount 800F enclosures.

‡ Crevices may exist on product that may be unsuitable for certain applications. Please consult your local Rockwell Automation distributor.

§ Only available in clear ("7" from Table d)

4-Position Selector Switch Operators, Non-Illuminated



Standard Knob  
 Cat. No. 800FP-SM42

Target Table and Operator Position*					
Contact Type§	Position on Mounting Latch				
N.O.	Left	O	O	X	O
	Right	X	O	O	O
	Center	X	O	X	O
	Center CL	O	O	X	O
	Center CR	X	O	O	O
N.C.E.B.	Left	O	O	O	X
	Right	O	X	O	O
	Center CL	O	O	O	X
	Center CR	O	X	O	O
N.C.L.B.	Left	X	X	O	X
	Right	O	X	X	X
	Center	O	X	O	X
	Center CL	X	X	O	X
	Center CR	O	X	X	X

Note: X = Closed/O = Open

§ Contact selection is limited to the following options, consult your Rockwell Automation distributor for other options.

Color	Standard Knob — Maintained		Pkg. Quantity
	Plastic	Metal	
	Cat. No.	Cat. No.	
Black with White Insert	800FP-SM42	800FM-SM42	1

800F **P** - **S** **M4** **2** - - - - -

*a*      *b*      *c*      *d*      *e*      *f*      *g*

**a**

Operator Construction	
Code	Description
P	Round plastic operator (IP66, Type 4/4X/13)
M	Round metal operator (IP66, Type 4/13)

**b**

Operator Type	
Code	Description
S	Standard knob
H	Knob lever

**c**

Operator Function	
Code	Type
M4	Maintained (45° switching angle) 

**d**

Knob/Insert Color		
Code	Knob Color	Insert Color
2	Black	White

**e**

Orientation	
Code	Description
Blank	Standard
N	90° offset*

**f**

Operation	
Code	Description
Blank	Standard
CL	Center Left†
CR	Center Right†

**g**

Packaging	
Code	Description
Blank	1 per package
BP	10 per package

\* Cannot use N.C. or N.O.E.M. contact blocks with 4-position selector switch. Must use N.O., N.C.E.B., or N.C.L.B. contact blocks.  
 † For use in vertical mount enclosures.  
 ‡ The center contact block can have the same target output as the left or right contact block, by specifying CenterLeft (CL) or CenterRight (CR) option.



Bulletin 800F  
**22.5 mm Push Buttons**  
 Product Selection, Continued

2-Position Key Operated Selector Switches, Non-Illuminated



Key Selector Switch  
 Cat. No. 800FP-KM21R

Switching Angle



Target Table and Operator Position*		
Contact Type➤		
N.O.	O	X
N.C.	X	O

Note: X = Closed/O = Open

➤ Contact selection is limited to the following options, consult your Rockwell Automation distributor for other options.

Key Removal Position	Operator Type 	Key Selector Switch Operators		Pkg. Quantity
		Plastic Cat. No.	Metal Cat. No.	
Left		800FP-KM21	800FM-KM21	1
Both		800FP-KM23	800FM-KM23	

\* Target table for spring return from left is reversed from what is shown in the table.

800F **M** - **KM2** **1** - - -

a            b            c            d            e

**a**

Operator Construction	
Code	Description
P	Round plastic operator (IP66, Type 4/13)
M	Round metal operator (IP66, Type 4/13)

**b**

Operator Type	
Code	Type
KM2	Maintained (60° switching angle)
KL2	Spring return from left (60° switching angle)
KR2	Spring return from right (60° switching angle)

**c**

Key Removal Position*	
Code	Position
1	Left
2	Right
3	Both

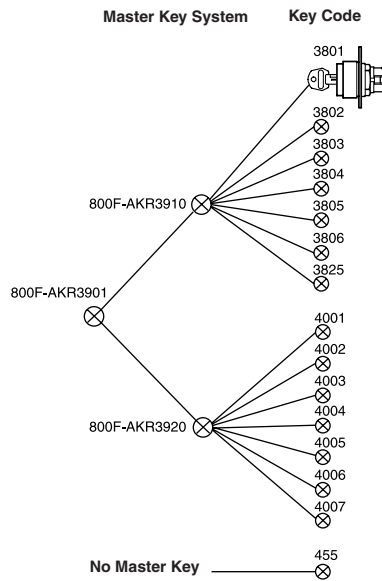

**d**

Ronis Key Lock†‡§	
Code	Key No.
Blank	3825 (Standard)
R	455
01R	3801
02R	3802
03R	3803
04R	3804
05R	3805
06R	3806
27R	4001
28R	4002
29R	4003
30R	4004
31R	4005
32R	4006
33R	4007

**e**

Packaging	
Code	Description
Blank	1 per package
BP	10 per package

\* Key removal in maintained positions only.

† Keyed operators are IP66, Type 4/13.

§ Not intended for high security applications. Interoperability is possible with certain key/cylinder lock combinations. Consult your local Allen-Bradley distributor for interoperability information.

‡ For Ronis replacement keys, see Accessories, page 53.

**3-Position Key Operated Selector Switches, Non-Illuminated**



Key Operated Selector Switch  
 Cat. No. 800FP-KM31R



Key Operated Selector Switch  
 Cat. No. 800FM-KM31R

**Switching Angle**

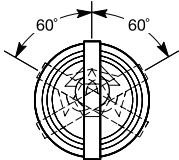

Target Table and Operator Position				
Contact Type	Position on Mounting Latch			
N.O.	Left	X	O	O
	Right	O	O	X
	Center	X	O	X
N.C.	Left	O	X	X
	Right	X	X	O
	Center	O	X	O

**Note:** X = Closed/O = Open  
 > Contact selection is limited to the following options, consult your Rockwell Automation distributor for other options.

Key Removal Position	Operator Position			Key Selector Switch Operators		Pkg. Quantity
				Plastic Cat. No.	Metal Cat. No.	
Left				800FP-KM31	800FM-KM31	1
All				800FP-KM33	800FM-KM33	
Center				800FP-KM34	800FM-KM34	
Center				800FP-KB34	800FM-KB34	

800F **M** - **KM3** **3** - - - - -  
 a b c d e

**a**

Operator Construction	
Code	Description
P	Round plastic operator (IP66, Type 4/13)
M	Round metal operator (IP66, Type 4/13)

**c**

Key Removal Position*	
Code	Type
1	Left
3	All
4	Center
5	Left/Center
7*	Center/Right

**d**  
 See page 28 for optional key codes\*†§

**b**

Operator Type	
Code	Description
KM3	Maintained
KR3	Spring return from right
KL3	Spring return from left
KB3	Spring return from both

**e**

Packaging	
Code	Description
Blank	1 per package
BP	10 per package

\* Key removal in maintained positions only.  
 † Keyed operators are IP66, Type 4/13.  
 ‡ Not intended for high security applications. Interoperability is possible with certain key/cylinder lock combinations. Consult your local Allen-Bradley distributor for interoperability information.  
 § For Ronis replacement keys, see Accessories, page 53.  
 \* Key removal position only valid with operator types 800F\_-KM3 and 800F\_-KL3.

Bulletin 800F  
**22.5 mm Push Buttons**  
 Product Selection, Continued

**Emergency Stop Operators\***

**Non-Illuminated Twist-to-Release, Push-Pull**



60 mm Non-Illuminated Twist-to-Release  
 Cat. No. 800FP-MT64



40 mm Non-Illuminated Push-Pull  
 Cat. No. 800FP-MP44

Color	Size	Twist-to-Release (Trigger Action)		Push-Pull (Trigger Action)		Pkg. Quantity
		Plastic	Metal	Plastic	Metal	
		Cat. No.	Cat. No.	Cat. No.	Cat. No.	
Red	30 mm	800FP-MT34	800FM-MT34	–	–	1
	40 mm	800FP-MT44	800FM-MT44	800FP-MP44	800FM-MP44	
	60 mm	800FP-MT64	800FM-MT64	–	–	

**Illuminated — Twist-to-Release, Push-Pull‡**



40 mm Illuminated Twist-to-Release  
 Cat. No. 800FP-LMT44



40 mm Mushroom Push/Pull  
 Cat. No. 800FM-LMP44

Color	Size	Twist-to-Release (Trigger Action)		Push-Pull (Trigger Action)		Pkg. Quantity
		Plastic	Metal	Plastic	Metal	
		Cat. No.	Cat. No.	Cat. No.	Cat. No.	
Red	30 mm	–	–	800FP-LMP34	800FM-LMP34	1
	40 mm	800FP-LMT44	800FM-LMT44	800FP-LMP44	800FM-LMP44	
	60 mm	800FP-LMT64	800FM-LMT64	800FP-LMP64	800FM-LMP64	

‡ LED module required for illumination, can not use incandescent module.

**Key Release Mushroom Operator**



40 mm Non-Illuminated Key Release  
 Cat. No. 800FP-MK44

Color	Size	Ronis Key Lock (Trigger Action)*		Pkg. Quantity
		Plastic	Metal	
		Cat. No.	Cat. No.	
Red	40 mm	800FP-MK44	800FM-MK44	1

\* All emergency stop operators are EN418 compliant with standard NC, NCLB, or self-monitoring contact blocks.

\* For key options, see page 28.



2-Position Push-Pull Operators, Non-Illuminated — Twist-to-Release (Trigger Action), Push-Pull (Trigger Action)\*



40 mm Trigger Action  
 Twist-to-Release Mushroom  
 Cat. No. 800FP-MT44



40 mm Trigger Action  
 Push-Pull Mushroom  
 Cat. No. 800FP-MP44

Color	40 mm Mushroom (Trigger Action) Twist-to-Release		40 mm Mushroom (Trigger Action) Push-Pull		Pkg. Quantity
	Plastic	Metal	Plastic	Metal	
	Cat. No.	Cat. No.	Cat. No.	Cat. No.	
Red	800FP-MT44	800FM-MT44	800FP-MP44	800FM-MP44	1



*a*

Operator Construction	
Code	Description
P	Round plastic operator (IP66, Type 4/4X/13)
M	Round metal operator (IP66, Type 4/13)

*b*

Operator Type	
Push, Twist-to-Release*	
Code	Type
MT3	30 mm color cap
MT4	40 mm color cap
MT6	60 mm color cap
Push-Pull	
Code	Type
MP4	40 mm color cap

*c*

Color Cap	
Code	Color
2	Black
3	Green
4	Red
5	Yellow
6	Blue

*d* ‡ § \*

Engraving	
Code	Description
Blank	
LE	EMO laser engraved
E	EMO printed

*e*

Packaging	
Code	Description
Blank	1 per package
BP	10 per package

\* All emergency stop operators are EN418 compliant with standard NC, NCLB, or self-monitoring contact blocks.  
 † Only available with red color cap.  
 ‡ For EMO guards, see page 56.  
 § Only available on 40 mm color cap.  
 \* Only available on red, 40 mm push, twist-to-release operator type (MT44).

Bulletin 800F  
**22.5 mm Push Buttons**  
 Product Selection, Continued

2-Position Push-Pull Operators, Illuminated — Twist-to-Release (Trigger Action), Push-Pull (Trigger Action)\*❄



40 mm Mushroom Trigger Action Twist-to-Release  
 Cat. No. 800FP-LMT44



40 mm Mushroom Push/Pull  
 Cat. No. 800FM-LMP44

Color	40 mm Mushroom (Trigger Action) Twist-to-Release		40 mm Mushroom (Trigger Action) Push-Pull		Pkg. Quantity
	Plastic	Metal	Plastic	Metal	
	Cat. No.	Cat. No.	Cat. No.	Cat. No.	
Red	800FP-LMT44	800FM-LMT44	800FP-LMP44	800FM-LMP44	1

800F **P** - **LMP4** **3** -       
           a          b          c          d

a

Operator Construction	
Code	Description
P	Round plastic operator (IP66, Type 4/4X/13)
M	Round metal operator (IP66, Type 4/13)

b

Operator Type	
Push, Twist-to-Release‡§	
Code	Type
LMT4	40 mm color cap
LMT6	60 mm color cap
Push-Pull	
Code	Type
LMP3	30 mm color cap
LMP4	40 mm color cap
LMP6	60 mm color cap

c

Lens Cap Color	
Code	Color
3	Green
4	Red
5	Yellow
6	Blue❄

d

Packaging	
Code	Description
Blank	1 per package
BP	10 per package

- \* LED module required for illumination, can not use incandescent module.
- ❄ All emergency stop operators are EN418 compliant with standard NC, NCLB, or self-monitoring contact blocks.
- ‡ Only available with red color cap.
- § 60 mm version has black arrows; 30 and 40 mm versions have white arrows.
- ❄ Only available with 40 mm Push-Pull color cap ("LMP4" from Table b).

2-Position Non-Illuminated Operators — Mushroom, Key Release (Trigger Action)\*



40 mm Key Release Mushroom  
 Cat. No. 800FP-MK44

Color	2-Position (Trigger Action) 40 mm Mushroom Key Release		Pkg. Quantity
	Plastic	Metal	
	Cat. No.	Cat. No.	
Red	800FP-MK44	800FM-MK44	1

Note: For Ronis replacement keys, see Accessories, page 53. Key release mushroom operators use key no. 3825.

800F **P** - **MK4** **4** **—** **—**  
 a b c d e

a

Operator Construction	
Code	Description
P	Round plastic operator (IP66, Type 4/13)
M	Round metal operator (IP66, Type 4/13)

b

Operator Type	
Key Release Mushroom	
Code	Type
MK4	40 mm

c

Lens Cap Color	
Code	Color
4	Red

d

Ronis Key Lock*†§	
Code	Key No.
Blank	3825 (Standard)
R	455
01R	3801
02R	3802
03R	3803
04R	3804
05R	3805
06R	3806
27R	4001
28R	4002
29R	4003
30R	4004
31R	4005
32R	4006
33R	4007

e

Packaging	
Code	Description
Blank	1 per package
BP	10 per package

\* All emergency stop operators are EN418 compliant with standard NC, NCLB, or self-monitoring contact blocks.

† Keyed operators are IP66, Type 4/13.

‡ Not intended for high security applications. Interoperability is possible with certain key/cylinder lock combinations. Consult your local Allen-Bradley distributor for interoperability information.

§ For Ronis replacement keys, see Accessories, page 53.



Bulletin 800F  
**22.5 mm Push Buttons**  
 Product Selection, Continued

**3-Position Push-Pull Operators, Illuminated & Non-Illuminated — Mushroom**



Illuminated 3-Position Push-Pull  
 Cat. No. 800FM-LMP44E3

Target Table and Operator Position*			
Contact Type*			
	Out	Center	In
N.O.	O	O	X
N.C.E.B.	X	O	O
N.C.L.B.	X	X	O

Note: X = Closed/O = Open

\* Contact selection is limited to the following options, consult your Rockwell Automation distributor for other options.

Operator Function	Operator Type	Color	Cat. No.	Pkg. Quantity
Momentary Out, Maintained Center, Momentary In	Illuminated*	Amber‡	800FM-LMM40E3	1
		Green	800FM-LMM43E3	
		Red	800FM-LMM44E3	
		Blue‡	800FM-LMM46E3	
		Clear‡	800FM-LMM47E3	
	Non-Illuminated	Black§	800FM-MM42E3	
		Green	800FM-MM43E3	
Red		800FM-MM44E3		
Momentary Out, Maintained Center, Maintained In	Illuminated*	Amber‡	800FM-LMP40E3	1
		Green	800FM-LMP43E3	
		Red	800FM-LMP44E3	
		Blue‡	800FM-LMP46E3	
		Clear‡	800FM-LMP47E3	
	Non-Illuminated	Black§	800FM-MP42E3	
		Green	800FM-MP43E3	
Red		800FM-MP44E3		

800F **M** - **L** **MM** **4** **4** **E3**  
 a b c d e f

a

Operator Construction	
Code	Description
M	Round metal operator (IP66, Type 4/13)

b

Operator Type	
Code	Description
L	Illuminated*
Blank	Non-Illuminated

c

Operator Function	
Code	Description
MM	Momentary Out, Maintained Center, Momentary In
MP	Momentary Out, Maintained Center, Maintained In

d

Cap Size	
Code	Description
4	40 mm Plastic

e

Cap Color	
Code	Description
0	Amber‡
2	Black§
3	Green
4	Red
6	Blue‡
7	Clear‡

f

Positions	
Code	Description
E3	3-Position

\* Cannot use N.C. or N.O.E.M. contact blocks with 3-position push-pull operators. Must use N.O., N.C.E.B., or N.C.L.B. contact blocks.

\* Available in integrated LED version only.

‡ Available in illuminated only.

§ Available in non-illuminated only.

Momentary Push Button Operators, Non-Illuminated — Mushroom\*



40 mm Mushroom  
 Cat. No. 800FM-MM42



60 mm Jumbo Mushroom  
 Cat. No. 800FP-MM63

Color	40 mm Mushroom		60 mm Mushroom		Pkg. Quantity
	Plastic	Metal	Plastic	Metal	
	Cat. No.	Cat. No.	Cat. No.	Cat. No.	
Black	800FP-MM42	800FM-MM42	800FP-MM62	800FM-MM62	1
Green	800FP-MM43	800FM-MM43	800FP-MM63	800FM-MM63	
Red	800FP-MM44	800FM-MM44	800FP-MM64	800FM-MM64	
Yellow	800FP-MM45	800FM-MM45	800FP-MM65	800FM-MM65	
Blue	800FP-MM46	800FM-MM46	800FP-MM66	800FM-MM66	

800F **P** - **MM4** **3** -

a                      b                      c                      d

a

Operator Construction	
Code	Description
P	Round plastic operator (IP65, Type 4/4X/13)
M	Round metal operator (IP65, Type 4/13)

b

Size and Operator Type	
Mushroom	
Code	Type
MM4	40 mm momentary
MM6	60 mm momentary

c

Color Cap	
Code	Color
2	Black
3	Green
4	Red
5	Yellow
6	Blue

d

Packaging	
Code	Description
Blank	1 per package
BP	10 per package

\* Momentary mushroom operators are IP65 rated.

Bulletin 800F  
**22.5 mm Push Buttons**  
 Product Selection, Continued

Momentary Push Button Operators, Illuminated — Mushroom\*



40 mm Mushroom  
 Cat. No. 800FP-LMM43

Color	40 mm Mushroom		Pkg. Quantity
	Plastic	Metal	
	Cat. No.	Cat. No.	
Green	800FP-LMM43	800FM-LMM43	1
Red	800FP-LMM44	800FM-LMM44	
Yellow	800FP-LMM45	800FM-LMM45	
Blue	800FP-LMM46	800FM-LMM46	
Clear	800FP-LMM47	800FM-LMM47	

800F **P** - **LMM4** **3** -       
           *a*        *b*        *c*        *d*

*a*

Operator Construction	
Code	Description
P	Round plastic operator (IP65, Type 4/4X/13)
M	Round metal operator (IP65, Type 4/13)

*c*

Lens Cap Color	
Code	Color
3	Green
4	Red
5	Yellow
6	Blue
7	Clear

*d*

Packaging	
Code	Description
Blank	1 per package
BP	10 per package

*b*

Size and Operator Type	
Mushroom	
Code	Type
LMM4	40 mm momentary

\* Momentary mushroom operators are IP65 rated.



2-Function Momentary Multi-Operator, Non-Illuminated



2-Function Momentary Multi-Operator Non-Illuminated  
 Cat. No. 800FP-U2E4F3

Position A			Position C			Plastic	Pkg. Quantity
Color	Type	Text	Color	Type	Text	Cat. No.	
Red	Extended	Blank	Green	Flush	Blank	800FP-U2E4F3	1
		O			I	800FP-U2EFFE	
		STOP			START	800FP-U2EBFA	

800F **P** - **U2** **E** **4** **F** **3** - **\_\_\_\_\_** (with button caps)  
*a b c d e f g*

800F **P** - **U2** **X** - **\_\_\_\_\_** (without button caps)  
*a b c g*

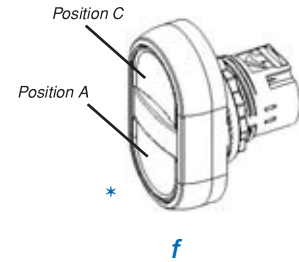

Operator Construction	
Code	Description
P	Plastic operator (IP66, Type 4/4X)
M	Metal operator (IP66, Type 4)

Operator Color Cap/Text — Position A‡	
Code	Description
1	White
2	Black
3	Green
4	Red
5	Yellow
6	Blue
A	Green with "Start" text
B	Red with "Stop" text
C	White with "Start" text
D	Black with "Stop" text
E	Green with "I" text
F	Red with "O" text
G	White with "I" text
H	Black with "O" text

Operator Color Cap/Text — Position C‡	
Code	Description
1	White
2	Black
3	Green
4	Red
5	Yellow
6	Blue
A	Green with "Start" text
B	Red with "Stop" text
C	White with "Start" text
D	Black with "Stop" text
E	Green with "I" text
F	Red with "O" text
G	White with "I" text
H	Black with "O" text

Operator Type	
Code	Description
U2	Two-function

Operator Type — Position A*	
Code	Description
F	Flush
E	Extended
X	No caps (all positions)*

Operator Type — Position C*	
Code	Description
F	Flush
E	Extended

Packaging	
Code	Description
Blank	1 per package
BP	10 per package

\* Position 1 of the latch (left position when viewed from the back) corresponds to position A of the operator. Position 2 of the latch (right position when viewed from the back) corresponds to position C of the operator.  
 \* For custom engraved caps, order "no caps" option plus custom engraved caps on page 60.  
 ‡ Valid color cap/legend text codes include:

Color	Text	
	Flush Caps	Extended Caps
White	START, I	—
Black	—	STOP, O
Green	START, I	—
Red	—	STOP, O

Bulletin 800F  
**22.5 mm Push Buttons**  
 Product Selection, Continued

2-Function Momentary Multi-Operator, Illuminated\*



2-Function Momentary Multi-Operator Illuminated  
 Cat. No. 800FP-LU2E2E1

Position A			Position B	Position C			Plastic	Pkg. Quantity
Color	Type	Text	Type	Color	Type	Text	Cat. No.	
Red	Extended	Blank	White Pilot Light	Green	Flush	Blank	800FP-LU2E4F3	1
		O				I	800FP-LU2EFFE	
		STOP				START	800FP-LU2EBFA	

800F **P** - **LU2** **E** **4** **F** **3** - (with button caps)  
 a b c d e f g

800F **P** - **LU2** **X** (without button caps)  
 a b c g

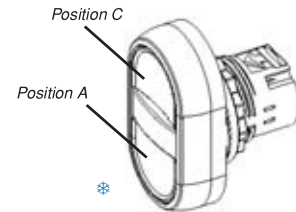

**a**

Operator Construction	
Code	Description
P	Plastic operator (IP66, Type 4/4X)
M	Metal operator (IP66, Type 4)

**b**

Operator Type*	
Code	Description
LU2	Two-function Illuminated

**c**

Operator Type — Position A*	
Code	Description
F	Flush
E	Extended
X	No caps (all positions)†

**d**

Operator Color Cap/Text — Position A§	
Code	Description
1	White
2	Black
3	Green
4	Red
5	Yellow
6	Blue
A	Green with "Start" text
B	Red with "Stop" text
C	White with "Start" text
D	Black with "Stop" text
E	Green with "I" text
F	Red with "O" text
G	White with "I" text
H	Black with "O" text

**e**

Operator Type — Position C*	
Code	Description
F	Flush
E	Extended

**f**

Operator Color Cap/Text — Position C§	
Code	Description
1	White
2	Black
3	Green
4	Red
5	Yellow
6	Blue
A	Green with "Start" text
B	Red with "Stop" text
C	White with "Start" text
D	Black with "Stop" text
E	Green with "I" text
F	Red with "O" text
G	White with "I" text
H	Black with "O" text

**g**

Packaging	
Code	Description
Blank	1 per package
BP	10 per package

\* LED module required for illumination, can not use incandescent module.

‡ Position 1 of the latch (left position when viewed from the back) corresponds to position A of the operator. Position 2 of the latch (right position when viewed from the back) corresponds to position C of the operator. Position 3 of the latch (center position) is reserved for the power module.

† For custom engraved caps, order "no caps" option plus custom engraved caps on page 60.

§ Valid color cap/legend text codes include:

Color	Text	
	Flush Caps	Extended Caps
White	START, I	—
Black	—	STOP, O
Green	START, I	—
Red	—	STOP, O

**3-Function Momentary Multi-Operator, Non-Illuminated**



3-Function Momentary Multi-Operator Non-Illuminated  
 Cat. No. 800FP-U3E4F34

Position A			Position B			Position C			Plastic	Pkg. Quantity
Color	Type	Text	Color	Type	Text	Color	Type	Text	Cat. No.	
Green	Flush	Blank	Red	Extended	Blank	Green	Flush	Blank	800FP-U3F3F34	1

800F **P** - **U3** **E** **4** **F** **3** **4** - (with button caps)  
 a b c d e f g h

800F **P** - **U3** **X** - (without button caps)  
 a b c h  
 a

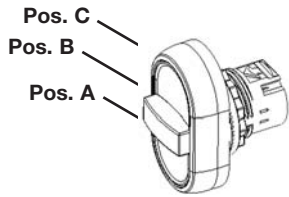

Operator Construction	
Code	Description
P	Plastic operator (IP66, Type 4/4X)
M	Metal operator (IP66, Type 4)

b

Operator Type	
Code	Description
U3	Three-function

c

Operator Type — Position A*	
Code	Description
F	Flush
E	Extended
X	No caps (all positions)*†

d

Operator Color Cap/Text — Position A§	
Code	Description
1	White
2	Black
3	Green
4	Red
5	Yellow
6	Blue

d (cont'd)

Operator Color Cap/Text — Position A§	
Code	Description
A	Green with "Start" text
B	Red with "Stop" text
C	White with "Start" text
D	Black with "Stop" text
E	Green with "I" text
F	Red with "O" text
G	White with "I" text
H	Black with "O" text

e

Operator Type — Position C*	
Code	Description
F	Flush
E	Extended

f

Operator Color Cap/Text — Position C§	
Code	Description
1	White
2	Black
3	Green
4	Red
5	Yellow
6	Blue

f (cont'd)

Operator Color Cap/Text — Position C§	
Code	Description
A	Green with "Start" text
B	Red with "Stop" text
C	White with "Start" text
D	Black with "Stop" text
E	Green with "I" text
F	Red with "O" text
G	White with "I" text
H	Black with "O" text

g

Operator Color Cap/Text — Position B*†	
Code	Description
4	Red
B	Red with "Stop" text
F	Red with "O" text

h

Packaging	
Code	Description
Blank	1 per package
BP	10 per package

\* Position 1 of the latch (left position when viewed from the back) corresponds to position A of the operator. Position 2 of the latch (right position when viewed from the back) corresponds to position C of the operator. Position 3 of the latch (center position) corresponds to position B of the operator.

† For custom engraved caps, order "no caps" option plus custom engraved caps on page 60.

‡ For "no caps" option, (position B) center cap available as red, no text only.

§ Valid color cap/legend text codes include:

Color	Text	
	Flush Caps	Extended Caps
White	START, I	—
Black	—	STOP, O
Green	START, I	—
Red	—	STOP, O

Bulletin 800F  
**22.5 mm Push Buttons**  
 Product Selection, Continued

Reset Operators — Mechanical and/or Electrical Reset



Reset Operator  
 Cat. No. 800FP-R611

Button Color	Legend Text	Flush — Round		Pkg. Quantity
		Plastic	Metal	
		Cat. No.	Cat. No.	
Blue	R	800FP-R611	800FM-R611	1
	No Legend	800FP-R6	800FM-R6	

800F **M** - **R** **6** **11** -

*a*
*b*
*c*
*d*
*e*

*a*

Operator Construction	
Code	Description
P	Round plastic operator (IP66, Type 4/4X/13)
M	Round metal operator (IP66, Type 4/13)

*b*

Operator Type	
Code	Type
R	Reset* <sup>‡</sup>

*d*

Legend Text	
Code	Text
Blank	No text
11	R

*c*

Color Cap	
Code	Color
1	White
2	Black
6	Blue

*e*

Packaging	
Code	Description
Blank	1 per package
BP	10 per package

\* Will accept latch and up to four single circuit contact blocks or two dual circuit contact blocks; no contacts allowed in center position.  
<sup>‡</sup> 11 mm reset stroke length.

Threaded Reset Rod Reset Operators



Threaded Reset Rod with 35 mm Pusher  
 Cat. No. 800F-ATR19L

Rod Length <sup>‡</sup>	Rod Length Adjustability	Threaded Reset Rod		Pkg. Quantity
		10 mm Pusher	35 mm Pusher	
		Cat. No.	Cat. No.	
40 mm	34...52 mm	800F-ATR01	800F-ATR01L	1
55 mm	50...67 mm	800F-ATR02	800F-ATR02L	
85 mm	80...98 mm	800F-ATR04	800F-ATR04L	
115 mm	110...128 mm	800F-ATR06	800F-ATR06L	
145 mm	141...159 mm	800F-ATR08	800F-ATR08L	
315 mm	157...326 mm	§ 800F-ATR19	§ 800F-ATR19L	

<sup>‡</sup> If contact blocks are used, they must have a minimum rod length of 55 mm for one level of contact blocks and 85 mm for two levels of contact blocks.  
 § Rod is threaded along its entire length. Fully threaded rod can be provided after cutting.



Single Turn Potentiometer Assembly\*†‡



Potentiometer Assembly  
 Cat. No. 800FP-POT1

Resistive Element	Cat. No.
None (Operator Only)*	800FP-POT
150 Ω	800FP-POT1
500 Ω	800FP-POT2
1000 Ω	800FP-POT3
2500 Ω	800FP-POT4
5000 Ω	800FP-POT5
10000 Ω	800FP-POT6

\* The 800FP-POT is a complete operator assembly supplied without the resistive element, used with potentiometers having a shaft diameter of 6.0 mm (0.23 in.) and a shaft length of 50.0 mm (1.97 in.), or a shaft diameter of 6.4 mm (0.25 in.) and a shaft length of 22.5 mm (0.88 in.). This operator is used with Type "J" potentiometers only.

‡ Rated 300V AC/DC, 2 W max.

† A latch is not needed.

Key Operated Selector Switch - SensEject™

Patent-Pending Spring-Loaded Key Ejection System



2-Position Switching Angle

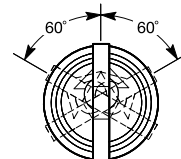

3-Position Switching Angle

Operator Construction	Operator Type	Key Eject Position	Key Option§*	Spare Keys	Contact Blocks	Cat. No. >
Round Metal Operator — SensEject is IP6X (dust-tight) Type 1	2-Position Maintained	 Left with Key Eject	Zadi Key 06Z	800F-AKE006	None	800FM-KEM2106Z
					1 N.O.; 1 N.C.	800FM-KEM2106ZMX11
	3-Position Spring Return from Both	 Center with Key Eject	Zadi Key 01Z	800F-AKE001	None	800FM-KEB3401Z
					2 N.O.; 3 N.C.	800FM-KEB3401ZMX23

§ Not intended for high security applications. Interoperability is possible with certain key/cylinder lock combinations. Consult your local Allen-Bradley distributor for interoperability information.

\* Consult your Allen-Bradley Distributor for more key options.

> Includes latch and spacer block.

Bulletin 800F  
**22.5 mm Push Buttons**  
 Product Selection, Continued

Selector Push Button Operators\*



Selector Jog Operator  
 Cat. No. 800FM-SJ23

Target Table and Operator Position (2-Position)					
Contact Type*	Position on Mounting Latch	↙		↗	
		Selector Left Free	Selector Left Depressed	Selector Right Free	Selector Right Depressed
N.O.	Left	O	X	O	O
N.O.	Right	O	O	O	X
N.O.	Center	O	X	O	X
N.C.	Left	X	O	X	X
N.C.	Right	X	X	X	O
N.C.	Center	X	O	X	O

Note: X = Closed/O = Open

Target Table and Operator Position (3-Position)							
Contact Type*	Position on Mounting Latch	↙		↑		↗	
		Selector Left Free	Selector Left Depressed	Selector Center Free	Selector Center Depressed	Selector Right Free	Selector Right Depressed
N.O.	Left	O	X	O	X	O	O
N.O.	Right	O	O	O	X	O	X
N.O.	Center	O	X	O	X	O	X
N.C.	Left	X	O	X	O	X	X
N.C.	Right	X	X	X	O	X	O
N.C.	Center	X	O	X	O	X	O

Note: X = Closed/O = Open

\* Contact selection is limited to the following options, consult your Rockwell Automation distributor for other options.

800F **P** - **SJ** **2** **2**  
           a      b      c      d

a

Operator Construction	
Code	Description
P	Round Plastic Operator (IP66, Type 4/4X/13)
M	Round Metal Operator (IP66, Type 4/13)

b

Operator Type	
Code	Description
SJ	Selector Jog

c

Operator Function	
Code	Description
2	2-Position
3	3-Position

d

Color Cap	
Code	Description
2	Black
3	Green

\* Buttons cannot be engraved.

Toggle Switch Operators\*❄



Toggle Switch Operator  
 Cat. No. 800FM-JM2

Target Table and Operator Position (2-Position)				
Contact Type§	Position on Mounting Latch			
		Toggle Left	Center	Toggle Right
N.O.	Left	O	O	X
N.O.	Right	X	O	O
N.O.	Center	X	O	X
N.C.	Left	X	X	O
N.C.	Right	O	X	X
N.C.	Center	O	X	O

Note: X = Closed/O = Open

Target Table and Operator Position (4-Position)‡						
Contact Type§	Position on Mounting Latch					
		Toggle Up	Toggle Left	Center	Toggle Right	Toggle Down
N.O.	Left	X	O	O	O	O
N.O.	Right	O	X	O	O	O
N.O.	Center	X	X	O	O	O
N.C.L.B.	Left	O	X	X	X	X
N.C.L.B.	Right	X	O	X	X	X
N.C.L.B.	Center	O	O	X	X	X
N.C.E.B.	Left	O	O	O	O	X
N.C.E.B.	Right	O	O	O	X	O

Note: X = Closed/O = Open

§ Contact selection is limited to the following options, consult your Rockwell Automation distributor for other options.

800F **M** – **J** **M2**  
           a      b      c

a

Operator Construction	
Code	Description
M	Round Metal Operator (IP66, Type 4/13)

b

Operator Type	
Code	Description
J	Toggle Switch

c

Operator Function	
Code	Description
M2	2-Position, Maintained
R2	2-Position, Momentary
M4	4-Position, Maintained
R4	4-Position, Momentary

\* Use legend plates 800F-34\_ and 800F-35\_.

❄ Silicone boot comes standard with toggle switch, please see page 54 for replacement boots.

‡ Cannot use N.C. or N.O.E.M. contact blocks with 4-position toggle switch. Must use N.O., N.C.E.B., or N.C.L.B. contact blocks.

Bulletin 800F  
**22.5 mm Push Buttons**  
 Product Selection, Continued

Back-of-Panel Components

Contact Blocks with Latch



800F – **P** **X** **0** **1** **E**  
*a* *b* *c* *d* *e*

*a*

Style	
Code	Description
P	Plastic latch
M	Metal latch

*b*

Contact Block(s) Termination Style*	
Code	Description
X	Screw termination
Q	Spring-clamp termination

\* Six circuits maximum allowable.

*c*

N.O. (Normally Open) Circuits	
Code	Description
0	No contact
1	1 N.O.
2	2 N.O.
3	3 N.O.
4	4 N.O.
5	5 N.O.
6	6 N.O.

*d*

N.C. (Normally Closed) Circuits	
Code	Description
0	No contact
1	1 N.C.
2	2 N.C.
3	3 N.C.
4	4 N.C.
5	5 N.C.
6	6 N.C.

*e*

Specialty Contact Block(s)	
Code	Description
Blank	Standard blocks
V	Low voltage — QuadCONNECT™
E	N.O. early make
L	N.C. late break
S	N.C. self-monitoring

Power Modules with Latch

800F – **M** **N** **3** **G**  
*a* *b* *c* *d*



*a*

Style	
Code	Description
P	Plastic latch
M	Metal latch

*b*

Power Module Type†§	
Code	Description
D	Incandescent module, screw termination
N	Integrated LED module, screw termination
Q	Integrated LED module, spring-clamp termination

*c*

Voltage	
Code	Description
0	No bulb‡
1	6V AC/DC‡
2	12V AC/DC‡
3	24V AC/DC
4	48V AC/DC‡
5	120V AC
7	240V AC>

*d*

Lamp Color‡	
Code	Description
C	Incandescent
R	Red LED
G	Green LED
Y	Amber LED
W	White LED
B	Blue LED

† LED modules for use with all illuminated operators. Incandescent module for use with pilot lights, momentary push buttons, and momentary mushroom operators only.

§ Four circuits maximum allowable when power module is used. Do not stack contact block on power module.

‡ Only available for incandescent module.

> Only available for integrated LED module.

‡ For best illumination results, LED color should match lens color. For yellow operator, select a white LED.



Back-of-Panel Components, Continued

Power Modules with Contact Blocks and Latch

800F – **P** **N** **5** **R** **X** **1** **0** **E**  
*a* *b* *c* *d* *e* *f* *g* *h*

*a*

Style	
Code	Description
P	Plastic latch
M	Metal latch

*b*

Power Module Type**	
Code	Description
D	Incandescent module, screw termination
N	Integrated LED module, screw termination
Q	Integrated LED module, spring-clamp termination

*c*

Voltage	
Code	Description
0	No bulb‡
1	6V AC/DC‡
2	12V AC/DC‡
3	24V AC/DC
4	48V AC/DC‡
5	120V AC
7	240V AC§

*d*

Lamp Color*	
Code	Description
C	Incandescent
R	Red LED
G	Green LED
Y	Amber LED
W	White LED
B	Blue LED

*e*

Contact Block(s) Termination Style	
Code	Description
X	Screw termination
Q	Spring-clamp termination

*f*

N.O. (Normally Open) Circuits	
Code	Description
0	No contact
1	1 N.O.
2	2 N.O.
3	3 N.O.
4	4 N.O.

*g*

N.C. (Normally Closed) Circuits	
Code	Description
0	No contact
1	1 N.C.
2	2 N.C.
3	3 N.C.
4	4 N.C.

*h*

Specialty Contact Block(s)	
Code	Description
Blank	Standard blocks
V	Low voltage — QuadCONNECT™
E	N.O. early make
L	N.C. late break
S	N.C. self-monitoring

\* Four circuits maximum allowable when power module is used. Do not stack contact block on power module.

\*\* LED modules for use with all illuminated operators. Incandescent module for use with pilot lights, push buttons, and momentary mushroom operators only.

‡ Only available for incandescent module.



§ Only available for integrated LED module.

‡ For best illuminated results, LED should match lens color. For yellow operator, select a white LED.

Bulletin 800F  
**22.5 mm Push Buttons**  
 Product Selection, Continued

Back-of-Panel Components, Continued

Other





	Description	Cat. No.	Pkg. Quantity		
  Cat. No. 800F-ALM	<b>Metal Mounting Latch</b> These are zinc-plated, metal die cast mounting latches. <b>Note:</b> Sold only in multiples of 10. Order (quantity of) 10 to receive one package of 10 pieces.	800F-ALM	10		
	<b>Note:</b> Sold only in multiples of 100. Order (quantity of) 100 to receive one package of 100 pieces.	800F-ALM-BP	100		
  Cat. No. 800F-ALP	<b>Plastic Mounting Latch</b> <b>Note:</b> Sold only in multiples of 10. Order (quantity of) 10 to receive one package of 10 pieces.	800F-ALP	10		
	<b>Note:</b> Sold only in multiples of 100. Order (quantity of) 100 to receive one package of 100 pieces.	800F-ALP-BP	100		
  Cat. No. 800F-X10	<b>Contact Block</b> <b>Note:</b> Sold only in multiples of 10. Order (quantity of) 10 to receive one package of 10 pieces.	<b>Description</b>	<b>Contact Type</b>	<b>Cat. No.</b>	<b>Pkg. Quantity</b>
		N.O.	800F-X10	10	
		N.C.	800F-X01		
		N.O.E.M.	800F-X10E		
		N.C.L.B.	800F-X01L		
		N.C.E.B.	* 800F-X01B		
		Self-Monitoring	* 800F-X01S		
		N.O. low voltage — QuadCONNECT™	800F-X10V		
		N.C. low voltage — QuadCONNECT™	800F-X01V		
		Dual circuit of 2 N.O.	* 800F-X20D		
		Dual circuit of 2 N.C.	* 800F-X02D		
		Dual circuit of 1 N.O.-1 N.C.	* 800F-X11D		
		N.O. with stab terminals	800F-X10T		
		N.C. with stab terminals	800F-X01T		
		N.O. spring-clamp	800F-Q10		
		N.C. spring-clamp	800F-Q01		
		N.O. spring-clamp low-voltage — QuadCONNECT™	800F-Q10V		
		N.C. spring-clamp low-voltage — QuadCONNECT™	800F-Q01V		
		N.O.E.M. spring-clamp	800F-Q10E		
		N.C.L.B. spring clamp	800F-Q01L		
N.C.E.B. spring-clamp	* 800F-Q01B				
<b>Note:</b> Sold only in multiples of 100. Order (quantity of) 100 to receive one package of 100 pieces. Latch not included.	N.O.	800F-X10-BP	100		
	N.C.	800F-X01-BP			

\* Only for use with 4-position selector switch, 4-position toggle switch, or 3-position push-pull operator.

\* Cannot stack.

Back of Panel Components, Continued

Other

	Description	Volts	Cat. No.	Pkg. Quantity
 Cat. No. 800F-D3C	<b>Incandescent Module</b> For use with pilot lights, push buttons, and momentary mushroom operators. <b>Note:</b> Sold in multiples of 10. Order (quantity of) 10 to receive one package of 10 pieces. Latch not included.	No bulb	800F-D0C	10
		6V AC/DC	800F-D1C	
		12V AC/DC	800F-D2C	
		24V AC/DC	800F-D3C	
		48V AC/DC	800F-D4C	
		120V AC/DC	800F-D5C	
 Cat. No. 800F-N3G	<b>Integrated LED Module</b> For use with all illuminated devices. For best results, LED should match lens color. For amber operators, use yellow LED. <b>Note:</b> Sold in multiples of 10. Order (quantity of) 10 to receive one package of 10 pieces. Latch not included.	24V AC/DC	* 800F-N3x	10
		120V AC	* 800F-N5x	
		240V AC	* 800F-N7x	
		24V AC/DC spring-clamp	* 800F-Q3x	
		120V AC spring-clamp	* 800F-Q5x	
		240V AC spring-clamp	* 800F-Q7x	
	Description	Contact Material	Cat. No.	Pkg. Quantity
 Cat. No. 800F-BX01	<b>Base Mounted Contact Block</b> Base mounted contact blocks can be used in plastic or metal enclosures. <b>Note:</b> Sold only in multiples of 10. Order (quantity of) 10 to receive one package of 10 pieces.	N.O.	800F-BX10	10
		N.C.	800F-BX01	
		N.O.E.M.	800F-BX10E	
		N.C.L.B.	800F-BX01L	
		N.O. low voltage — QuadCONNECT™	800F-BX10V	
		N.C. low voltage — QuadCONNECT™	800F-BX01V	
		N.O. spring-clamp	800F-BQ10	
		N.C. spring-clamp	800F-BQ01	
	Description	Volts	Cat. No.	Pkg. Quantity
 Cat. No. 800F-BN3R	<b>Base Mounted Integrated LED Module</b> Base mounted modules can be used in plastic or metal enclosures. For best illumination results, LED should match lens color. <b>Note:</b> Sold in multiples of 10. Order (quantity of) 10 to receive one package of 10 pieces.	24V AC/DC	* 800F-BN3x	10
		120V AC	* 800F-BN5x	
		240V AC	* 800F-BN7x	
		24V AC/DC spring-clamp	* 800F-BQ3x	
		120V AC spring-clamp	* 800F-BQ5x	
		240V AC spring-clamp	* 800F-BQ7x	

\* To complete the cat. no., replace the x with one of the following letters for the desired color: **Y** = Amber, **R** = Red, **G** = Green, **B** = Blue, **W** = White.

Bulletin 800F  
**22.5 mm Push Buttons**  
 Product Selection, Continued

**Plastic and Metal Enclosures**



Plastic Enclosure  
 Cat. No. 800F-3PM



Metal Enclosure  
 Cat. No. 800F-5MM



Pendant Station  
 Cat. No. 800F-P25

**Plastic Enclosures (Latch or Base Mounting)**

- Accepts two-piece snap-in legends
- One-hole enclosure accepts 60 mm emergency stop legends
- Double insulated
- UL Listed, CSA Certified

**Metal Enclosures (Latch or Base Mounting)**

- Feed-through design
- Accepts two-piece snap-in legends
- Includes base mount adapter

**Pendant Stations (Latch Mounting)**

- Blank legend cap marking
- Connector not included. See Accessories, page 52, for ordering information.

Type	Enclosures				Pkg. Quantity
	Plastic (IP66, 4/4X)*		Metal — Die Cast (IP66, 4/13)*		
	PG Knockouts	Metric Knockouts	PG Conduit Openings	Metric Conduit Openings	
	Cat. No.	Cat. No.	Cat. No.	Cat. No.	
1 hole	800F-1PP	800F-1PM	800F-1MP	800F-1MM	1
2 hole	800F-2PP	800F-2PM	800F-2MP	800F-2MM	
3 hole	800F-3PP	800F-3PM	800F-3MP	800F-3MM	
4 hole	800F-4PP	800F-4PM	—	—	
5 hole	—	—	800F-5MP	800F-5MM	
6 hole	800F-6PP	800F-6PM	—	—	
1 hole (yellow)	800F-1LYP	800F-1YM	800F-1MYP	800F-1MYM	1
1 hole (yellow) Latch only	—	—	800F-1LYP	800F-1LYM	

\* Can only use single deep contact block.

\* Can stack contact blocks two deep or one dual circuit contact block.

Type	Knockout/Conduit Openings for Enclosures			
	Plastic		Metal	
	PG	Metric	PG	Metric
	Cat. No.	Cat. No.	Cat. No.	Cat. No.
1 hole	PG11/16	M16/20	PG11/16	M16/20
2 hole	PG11/16	M16/20	PG11/16	M16/20
3 hole	PG11/16	M16/20	PG11/16	M16/20
4 hole	PG11/16	M16/20	—	—
5 hole	—	—	PG16	M25/32
6 hole	PG16	M25	—	—

Type	Pendants		Pkg. Quantity
	Yellow Plastic (IP66, 4/4X/13)		
	Cat. No.		
1 hole in face	800F-P15		1
2 holes in face	800F-P25		
1 hole in bottom	800F-P35		
1 hole in face / 1 hole in bottom	800F-P45		



Assembled Stations



1-Hole Plastic Enclosure with E-Stop Operator  
 Cat. No. 800F-1YP4

1-Hole Yellow Enclosure E-Stop Station

Enclosure Material	Quick Connect	Operator Type	Illumination Voltage	Contact Configuration	Cat. No.	
					PG Knockouts	Metric Knockouts
Plastic	N/A	Twist-to-Release 40 mm	Non-Illuminated	1 N.C.	800F-1YP1	800F-1YM1
				1 N.O. / 1 N.C.	800F-1YP2	800F-1YM2
				2 N.C.	800F-1YP3	800F-1YM3
		1 N.C.		800F-1YP4	800F-1YM4	
		1 N.O. / 1 N.C.		800F-1YP5	800F-1YM5	
		2 N.C.		800F-1YP6	800F-1YM6	
		2 N.C.		800F-1YP7	—	
	Micro-QD	Twist-to-Release 40 mm	24V AC/DC	1 N.C.	—	800F-1YML1
			120V AC		—	800F-1YML2
			240V AC		—	800F-1YML3
			Non-Illuminated	—	—	800F-1YMQA
				1 N.C.	—	800F-1YMQ1
				1 N.O. / 1 N.C.	—	800F-1YMQ2
				2 N.C.	—	800F-1YMQ3
Metal	Mini Receptacle	24V AC/DC	1 N.O. / 1 N.C.	—	800F-1YMQ4	
		120V AC		—	800F-1YMQ5	
		240V AC		—	800F-1YMQ6	
		24V AC/DC		—	800F-1MYMQ4	
		120V AC		—	800F-1MYMQ5	
		240V AC		—	800F-1MYMQ6	

1-Hole Gray Enclosure E-Stop Station

Enclosure Material	Quick Connect	Operator Type	Illumination Voltage	Contact Configuration	Cat. No.	
					PG Knockouts	Metric Knockouts
Metal	N/A	Twist-to-Release 40 mm	Non-Illuminated	1 N.C.	—	800F-1MM1
				1 N.O. / 1 N.C.	—	800F-1MM2
				2 N.C.	—	800F-1MM3
		Key Release 40 mm		1 N.C.	—	800F-1MM4
				1 N.O. / 1 N.C.	—	800F-1MM5
				2 N.C.	—	800F-1MM6

Gray Enclosure Assembled Stations

Enclosure Material	Quick Connect	Operator Type	Illumination Voltage	Contact Configuration	Cat. No.	
					PG Knockouts	Metric Knockouts
1-Hole Plastic	N/A	Black Push Button	Non-Illuminated	1 N.O.	800F-1PP1	800F-1PM1
		"0-1" 2-Position Selector Switch		1 N.O.	800F-1PP2	800F-1PM2
		"OFF-ON" 2-Position Selector Switch		1 N.O. / 1 N.C.	800F-1PP3	800F-1PM3
		↔ (Flush Black)		1 N.O.	800F-1PP4	—
2-Hole Plastic		Start and Stop Push Buttons		1 N.O./1 N.C.	800F-2PP1	—
3-Hole Plastic		↑ (Flush Black) O (Extended Red) ↓ (Flush Black)		4 N.O./1 N.C.	800F-3PP1	—

Bulletin 800F  
**22.5 mm Push Buttons**  
 Product Selection, Continued

Assembled Stations with DeviceNet

2-Hole

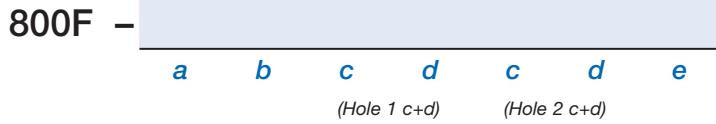

3-Hole

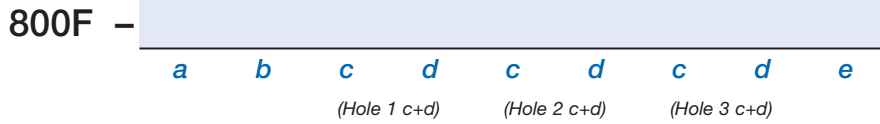

4-Hole

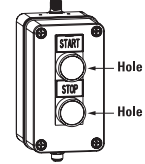
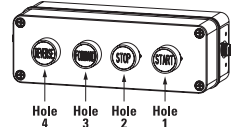
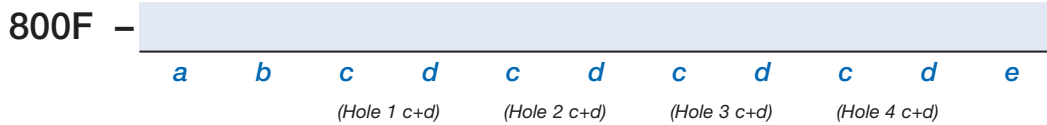

4-Hole Assembled Station  
 Cat. No. 800F-VHA3A4J3J4J

Mounting Orientation	
Code	Description
V	Vertical*
H	Horizontal

Enclosure Style/Legends	
Code	Description
D	2-Hole/No Legend Frames
E	3-Hole/No Legend Frames
F	4-Hole/No Legend Frames
H	2-Hole/E-Stop Only No Legend Frames*

Operator Types	
Code	Description
A	Non-Illuminated Flush Button
B	Non-Illuminated Extended Button
C	Non-Illuminated Guarded Button
D	Illuminated Flush Button+
E	Illuminated Extended Button+
F	Illuminated Guarded Button+
G	Non-Illuminated 2-Pos. Selector Switch
H	Non-Illuminated 3-Pos. Selector Switch
J	Pilot Light (Diffused)
K	Hole Plug
L	Non-Illuminated TTR E-Stop‡
M	Non-Illuminated Push Pull‡
N	2-Pos. Key Selector Switch
P	3-Pos. Key Selector Switch
R	Non-Illuminated 40 mm Mushroom
T	E-Stop Key Release‡
U	Potentiometer§
W	Illuminated Push Pull
X	Illuminated 2-Pos. Maintained Selector Switch
Y	Illuminated 3-Pos. Maintained Selector Switch
Z	Illuminated 40 mm Mushroom

Color/Text	
Code	Description
1	White
2	Black
3	Green
4	Red
5	Yellow
6	Blue
7	Clear
8	Gray♣
9	No Cap
0	Amber
A	Green with "Start" Text
B	Red with "Stop" Text
C	Black with "→" Symbol
D	Black with "←" Symbol
E	Black with "↑" Symbol
F	Black with "↓" Symbol
G	Green with "I" Symbol
H	Red with "O" Symbol
L	Blue with "R" Text

I/O Version➤	
Code	Description
Blank	No External I/O
A	1 Input/1 Output (Sinking)
B	1 Input/1 Output (Sourcing)
C	2 Input
D	2 Output (Sinking)
E	2 Output (Sourcing)
F	1 E-Stop Block⌘
G	2 E-Stop Block⌘
H	2 Input/2 Output
J	2 Input/2 Output (Sinking)
K	2 Input/2 Output (Sourcing)
L	1 Input/1 Output (Sinking) + 1 E-Stop Block⌘
M	1 Input/1 Output (Sourcing) + 1 E-Stop Block⌘
N	1 Input/1 Output (Sinking) + 2 E-Stop Block⌘
P	1 Input/1 Output (Sourcing) + 2 E-Stop Block⌘
Q	2 Input + 1 E-Stop Block⌘
R	2 Input + 2 E-Stop Block⌘
T	2 Output (Sinking) + 1 E-Stop Block⌘
U	2 Output (Sourcing) + 1 E-Stop Block⌘
V	2 Output (Sinking) + 2 E-Stop Block⌘
W	2 Output (Sourcing) + 2 E-Stop Block⌘
X	2 Input + 1 Input/1 Output (Sinking)
Y	2 Input + 1 Input/1 Output (Sourcing)

- \* Selector Switches in a vertical mount enclosure are mounted with a horizontal orientation.
- ⌘ Enclosure Style/Legend option H from Table b can only select one operator from Table c. Valid options are L, M and T. Also see Footnote 3.
- ‡ Operator Types L, M, and T from Table c maybe used as emergency stops. To be valid as an E-Stop, operators must use color/text option 4 from Table d and it must be placed in the last hole position in the enclosure. An E-Stop connector also must be chosen from Table e. Also see Footnote ⌘
- § Potentiometer allowed in first hole position only.
- ♣ Available in flush only.
- This is an 8-in/4-out device. 2-in and 1-out are assigned to each hole position in the enclosure. If a 2-hole enclosure is selected, 4-in and 2-out are assigned internally and up to 4 unassigned I/O points can be assigned to external connectors. This device contains up to two physical external I/O connectors. The "+" symbol in the Description field of table e indicates that two external connectors exist. If an E-Stop connector is used, 2 unassigned I/O points can be assigned to the other connector.
- ⌘ External I/O Versions F, L, M, Q, T, and U receive only one contact block for the external E-Stop string. These connectors are rated 3 A. If more than 3 A of current is needed or if there are two E-Stop strings, use External I/O Versions G, N, P, R, V and W. These versions receive two contact blocks. This allows for 6 A of switching or for two E-Stop strings.
- + Cannot be ordered with "No Cap" ("9" from Table d - Color/Text)

Pendant Stations\*



Pendant Station  
 Cat. No. 800F-PN2

Type	Pendants		Pkg. Quantity
	Yellow Plastic (IP66, 4/4X/13)		
	Cat. No.		
1 hole in face	800F-P15		1
2 holes in face	800F-P25		
1 hole in bottom	800F-P35		
1 hole in face / 1 hole in bottom	800F-P45		









DeviceNet Pendant Station with Mini Quick Disconnect Connector	
Cat. No.	Options
800F-PND2	Green Flush PB in Face, Red Pilot Light in Bottom; 24V DC

Pre-Wired Pendant Station with Mini Quick Disconnect Connector	
Cat. No.	Push Button and Contact Selection
800F-PN2	Green Flush (No Text) in Face with 1 N.O. Contact; Red Pilot Light in Bottom with 1 N.O. Contact; 24V AC/DC
800F-P251	White Flush (with "Up" Arrow — ↑) with 1 N.O. Contact; Black Flush (with "Down" Arrow — ↓) with 1 N.O. Contact
800F-P252	Black Flush (with "Forward" Text) with 1 N.O. Contact; Black Flush (with "Reverse" Text) with 1 N.O. Contact
800F-P253	Black Flush (with "On" Text) with 1 N.O. Contact; Black Flush (with "Off" Text) with 1 N.C. Contact
800F-P254	Green Flush (with "Start" Text) with 1 N.O. Contact; Red Flush (with "Stop" Text) with 1 N.C. Contact
800F-P255	2 Flush Black Push Buttons (No Text), each with 1 N.O. Contact

\* Can only use single deep contact block.

Bulletin 800F  
**22.5 mm Push Buttons**  
 Accessories

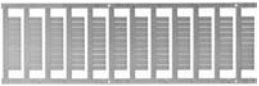





Miscellaneous

	Description	Type	Cat. No.	Pkg. Quantity
 Cat. No. 800F-AHA1	<b>30.5 mm to 22.5 mm Hole Size Adapter</b> This adapter allows a 22.5 mm push button operator to be installed in a panel with existing 30.5 mm mounting holes. <b>Note:</b> Comes with anti-rotation washer (800F-ALC1).	Metal	800F-AHA1	1
 Cat. No. 888N-M4AF1-1F	<b>Quick Disconnect</b> This is a male receptacle for pendant stations.	4-pin	888N-M4AF1-1F	
		5-pin	888N-M5AF1-1F	
	Description	Material	Cat. No.	Pkg. Quantity
 Cat. No. 800F-ARP	<b>Replacement Mounting Rings</b> <b>Note:</b> All replacement mounting rings are sold only in multiples of 10. Order (quantity of) 10 to receive one package of 10 pieces.	Plastic	800F-ARP	10
		Metal	800F-ARM	
	Description	Volts	Cat. No.	Pkg. Quantity
 Cat. No. 800F-XD7	<b>Diode Module</b> For lamp checking circuits.	up to 250V AC	800F-XD7	10
	<b>Null Block</b> For wire terminations only.	up to 600V AC	800F-NX70	
	Description		Cat. No.	Pkg. Quantity
 Cat. No. 800F-AW2	<b>Mounting Ring Wrench</b> This mounting ring wrench is used to tighten plastic or metal mounting rings quickly and securely.		800F-AW2	1
 Cat. No. 800F-ALR1	<b>Bulb Removal Tool</b> This item provides an extra anti-rotation feature for rotary operators such as selector switches. <b>Note:</b> Sold only in multiples of 10. Order (quantity of) 10 to receive one package of 10 pieces.		800F-ALR1	
 Cat. No. 800F-ALC1	<b>Locking Washer (Anti-Rotation Washer)</b> This item provides an extra anti-rotation feature for rotary operators such as selector switches. <b>Note:</b> Sold only in multiples of 10. Order (quantity of) 10 to receive one package of 10 pieces.		800F-ALC1	10
 Cat. No. 1492-MS5X9	<b>Snap-In Marker</b> This item can be used for circuit identification on all back-of-panel components.		*	—
 Cat. No. 800F-ATK2	<b>Stab Terminals</b> Can be used with all single circuit contact blocks. Minimum spacing requirements apply. See instruction sheet for details. <b>Note:</b> Sold only in multiples of 100. Order (quantity of) 100 to receive one package of 100 pieces.		800F-ATK2	100

\* See Terminal Block section for ordering information.



Miscellaneous, Continued

	Description	Cat. No.	Pkg. Quantity	
 Cat. No. 800F-AGS1	<b>Ground Screws</b> These are self-tapping #6-32 (M3.5) ground screws for metal latches. <b>Note:</b> Sold only in multiples of 10. Order (quantity of) 10 to receive one package of 10 pieces.	800F-AGS1	10	
 Cat. No. 800F-AGS2	<b>Ground Screws</b> This accessory is used for grounding on Bulletin 800F plastic enclosures only. <b>Note:</b> Sold only in multiples of 10. Order (quantity of) 10 to receive one package of 10 pieces.	800F-AGS2		
	Description	Key No. (Std)	Cat. No.	Pkg. Quantity
 Cat. No. 800F-AKR3825	<b>Replacement Ronis Key</b> Standard replacement key is Cat. No. 800F-AKR3825.	3825	<a href="#">800F-AKR3825</a>	1* ‡
		455	800F-AKR455	
		3801	800F-AKR3801	
		3802	800F-AKR3802	
		3803	800F-AKR3803	
		3804	800F-AKR3804	
		3805	800F-AKR3805	
		3806	800F-AKR3806	
		3901*	800F-AKR3901	
		3910*	800F-AKR3910	
		3920*	800F-AKR3920	
		4001	800F-AKR4001	
		4002	800F-AKR4002	
		4003	800F-AKR4003	
	4004	800F-AKR4004		
	4005	800F-AKR4005		
	4006	800F-AKR4006		
	4007	800F-AKR4007		
	Description	Cat. No.	Pkg. Quantity	
 Cat. No. 800F-ATW1	<b>Replacement Trim Washer</b> This accessory comes standard with all enclosures. It must be utilized if using base-mounted contact blocks/power modules without legend plates.	800F-ATW1		
 Cat. No. 800F-A3BA	<b>Replacement Base Mount Adapter</b> This accessory comes standard with all metal enclosures. It is required when using metal enclosures with base-mounted contact blocks or base-mounted power modules.	800F-A3BA	10‡	
 Cat. No. 800F-ABZ1	<b>Square Bezel</b> Gives round operator a square appearance. This item is made of plastic. Not for use with toggle switch operators.	800F-ABZ1		







\* Master key. See page 28 for details.

\* Standard package quantity is one set with two keys.







‡ Sold only in multiples of 10. Order (quantity of) 10 to receive one package of 10 pieces.

Bulletin 800F  
**22.5 mm Push Buttons**  
 Accessories, Continued

Miscellaneous, Continued





	Description	Material	Cat. No.	Pkg. Quantity
 Cat. No. 800F-ABJS	<b>Replacement Boot</b> for Toggle Switch	Silicone	800F-ABJS	1
		Nitrile	800F-ABJN	
 Cat. No. 800F-N2	<b>Hole Plug</b> used to plug 22.5mm holes.	Black Plastic	800F-N2	1
		Gray Plastic	800F-N8	
 Cat. No. 800F-30WN	<b>Potentiometer Legend Plate</b> scale 1-10 <b>Note:</b> Sold in multiples of 10. Order (quantity of) 10 to received one package of 10 pieces.	—	800F-30WN	10
 Cat. No. 800F-30WG	<b>Potentiometer Legend Plate</b> graphical scale <b>Note:</b> Sold in multiples of 10. Order (quantity of) 10 to received one package of 10 pieces.	—	800F-30WG	
	Description	Resistance	Cat. No.	Pkg. Quantity
 Cat. No. 800F-AC1	<b>Replacement Resistive Elements</b> for the 800FP Potentiometer operator.	150Ω	800F-AC1	1
		500Ω	800F-AC2	
		1000Ω	800F-AC3	
		2500Ω	800F-AC4	
		5000Ω	800F-AC5	
		10000Ω	800F-AC6	
 Cat. No. 800F-ACP	<b>Selector Switch Tabs</b> Changes functionality of selector switch from normal to CenterLeft or CenterRight.	—	800F-ACP	10



Locking Attachments

	Description	Type	Cat. No.	Pkg. Quantity
 Cat. No. 800F-AFL1	<b>Locking Attachments</b> are used to lock Push Button in the depressed position. -N.C. contacts are open -N.O. contacts may or may not be open -N.C.L.B. contacts may or may not be closed -N.O.E.M contacts are closed	Flush Momentary, Non-Illuminated	800F-AFL1	1
 Cat. No. 800F-AEL1		Extended Momentary, Non-Illuminated	800F-AEL1	
 Cat. No. 800F-AML1		Momentary Mushroom	800F-AML1	
 Cat. No. 800F-AML2		Maintained Mushroom	800F-AML2	
	Description	Lock Position	Cat. No.	Pkg. Quantity
 Cat. No. 800F-ASL2L	<b>Selector Switch Locking Attachment</b> Locks standard knob selector switch in specified position	2-Position Selector Switches, Left Lock	800F-ASL2L	1
		3-Position Selector Switches, Center Lock	800F-ASL3C	
 Cat. No. 800F-ASL23A	<b>Selector Switch Locking Attachment</b> Ability to put two locks on standard knob selector switch.	2- or 3-Position Selector Switches, All Positions	800F-ASL23A	
	Description	Type	Cat. No.	Pkg. Quantity
 Cat. No. 800F-AL01	<b>Locking Cover</b> Used on Flush, Extended and Guarded Momentary and Alternate Action Operators, and Standard Knob Selector Switch Operators.	—	800F-AL01	1

Bulletin 800F  
**22.5 mm Push Buttons**  
 Accessories, Continued

Guards

	Description	Type	Cat. No.	Pkg. Quantity
 Cat. No. 800F-AMRG	<b>Protective Ring</b> for use with Illuminated and Non-Illuminated 2 Position Push-Pull, and Non-Illuminated Momentary Mushroom operators (40mm only)	Shiny Metal	800F-AMRG	1
		Black	800F-AMRGB	
		Yellow Metal	800F-AMRGY	
 Cat. No. 800F-A6PR5	<b>Plastic Guard</b> for use with the following operators: -40 mm E-Stop (SEMI Standards Compliant); -40 mm Illuminated/Non-Illuminated Alternate Action and Momentary operators; -60 mm Illuminated/Non-Illuminated Momentary operators; -Selector Switches; -Potentiometer; -Key Operated Selector Switches	Yellow, Round	800F-A6PR5	1
 Cat. No. 800F-AMEGY	<b>Narrow Plastic Guard</b> for use with the following operators: -Illuminated and non-illuminated momentary mushroom operators (40 mm) only; -800FD Monolithic E-Stops; -Flush/Extended/Guarded Push Buttons; -Alternative Action Operators (SEMI standards compliant); -Selector Switches (standard knob and key operated); -Potentiometers	Yellow	800F-AMEGY	
 Cat. No. 800F-AMMG	<b>40 mm Protective Guard</b> used with illuminated and non-illuminated momentary mushroom operators (40 mm) only.	Shiny Metal	800F-AMMG	
 Protective Boots	Clear Silicone <b>Protective Boot</b> used on Illuminated and Non-Illuminated, flush and extended operators. <b>Note:</b> Sold in multiples of 10. Order (quantity of) 10 to received one package of 10 pieces.	Flush Push Button	800F-AB7	10
		Extended Push Button	800F-ABE7	
		3-Position Multi-Function	800F-AUB1	
		2-Position Multi-Function	800F-AUB2	

Lamp	Type	Typical Current	Voltage	ANSI No.	Cat. No.	Pkg. Quantity
 Cat. No. 800F-N130	Full Voltage Incandescent	150 mA	6V AC/DC	755	800F-N65	10*
		80 mA	12V AC/DC	756	800F-N141	
		70 mA	24V AC/DC	757	800F-N157	
		50 mA	48V AC/DC	1835	800F-N48	
		22 mA	130V AC/DC	949	800F-N130	
 Cat. No. 800F-N240	Neon	22 mA	240V AC	—	800F-N240	10*
	LED	14 mA/48 mA	6V AC/DC	—	‡ 800T-N318x	
		12 mA/17 mA	32V AC/DC	—	‡ 800T-N363x	
		9 mA/14 mA	48V AC/DC	—	‡ 800T-N364x	
		4.5 mA/6.2 mA	130V AC/DC	—	‡ 800T-N321x	

\* Sold in multiples of 10. Order (quantity of) 10 to receive one package of 10 pieces.

‡ To complete the cat. no., replace the "x" with one of the following letters for the desired color: **A** = Amber; **B** = Blue; **G** = Green; **R** = Red; **W** = White. White LEDs only available in 6V and 130V.



Color caps listed below are for completion of devices ordered with color caps omitted.

**Accessory Color Caps (without Text)**

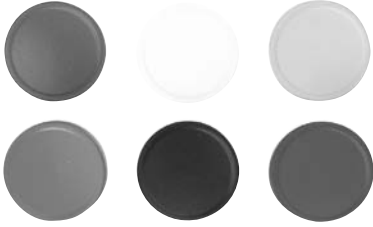
	Color Caps, Non-Illuminated*				Pkg. Quantity
	Color	Momentary Extended	Momentary Flush/Guarded	Alternate Action Flush	
		Cat. No.	Cat. No.	Cat. No.	
	Orange	800F-AE0	800F-AF0	800F-AFA0	10
	White	800F-AE1	800F-AF1	800F-AFA1	
	Black	800F-AE2	800F-AF2	800F-AFA2	
	Green	800F-AE3	800F-AF3	800F-AFA3	
	Red	800F-AE4	800F-AF4	800F-AFA4	
	Yellow	800F-AE5	800F-AF5	800F-AFA5	
	Blue	800F-AE6	800F-AF6	800F-AFA6	
	Gray	—	800F-AF8	—	

**Accessory Color Caps — Multi-Function Operators (without Text)**

	Color Caps, Non-Illuminated*			Pkg. Quantity
	Color	Flush	Extended	
		Cat. No.	Cat. No.	
	White	800F-AFU1	800F-AEU1	10
	Black	800F-AFU2	800F-AEU2	
	Green	800F-AFU3	800F-AEU3	
	Red	800F-AFU4	800F-AEU4	
	Yellow	800F-AFU5	800F-AEU5	
	Blue	800F-AFU6	800F-AEU6	

**Accessory Color Lens Caps and Pilot Light Lenses (without Text)**

	Color	Illuminated Color Lens Caps* — Flush, Alternate Action	Illuminated Color Lens Caps* — Extended, Guarded	Pilot Light Lenses* — Standard Lens	Pkg. Quantity
		Cat. No.	Cat. No.	Cat. No.	
	Amber	800F-ALF0	800F-ALE0	800F-AP0	10
	Green	800F-ALF3	800F-ALE3	800F-AP3	
	Red	800F-ALF4	800F-ALE4	800F-AP4	
	Yellow	800F-ALF5	800F-ALE5	800F-AP5	
	Blue	800F-ALF6	800F-ALE6	800F-AP6	
	Clear	800F-ALF7	800F-ALE7	800F-AP7	

\* Sold only in multiples of 10. Order (quantity of) 10 to receive one package of 10 pieces.

\* Includes diffuser.

**Operator Diffusers (without Text)**

	Diffusers		
	Description	Cat. No.	Pkg. Quantity
 Cat. No. 800F-AD3	Illuminated Push Buttons — Flush	800F-AD2	10
	Pilot Lights	800F-AD3	
	Illuminated Push Buttons — Extended, Guarded	800F-AD4	

Bulletin 800F  
**22.5 mm Push Buttons**  
 Accessories, Continued

Two-Color Molded Legend Caps — Non-Illuminated Push Buttons

800F – **AF** **3** **01**  
*a* *b* *c*



*a*

Button Cap Type	
Code	Description
AF	Flush
AE	Extended

*b*

Color Cap	
Code	Description
1	White
2	Black
3	Green
4	Red
5	Yellow
6	Blue

*c*

Legend Text*‡	
English	
Code	Description
01	START
02	STOP
05	O
06	I
08	→
09	FORWARD*
10	REVERSE*
11	R

\* Available in flush only.

\* White and yellow caps have black text. All other color caps have white text.

‡ Valid color cap text codes include:

Color	Text	
	Flush Caps	Extended Caps
White	FORWARD, REVERSE, START, I, →, R	→, R
Black	FORWARD, REVERSE, →, R	STOP, O, →, R
Green	FORWARD, REVERSE, START, I, →	→
Red	FORWARD, REVERSE, STOP, O, →	STOP, O, →
Yellow	FORWARD, REVERSE, →	→
Blue	FORWARD, REVERSE, →, R	→, R

Emergency Stop Legend Plates§

800F – **15** **Y** **c**  
*a* *b* *c*



*a*

Size	
Code	Description
15	60 mm round
16	90 mm round

*b*

Color	
Code	Description
Y	Yellow*
YS	Yellow➤

*c*

Text	
Code	Description
Blank	No text
E112	EMERGENCY STOP
F112	ARRÊT D'URGENCE
G112	NOT AUS
T112	ARRESTO EMERGENZA
S112	PARADA DE EMERGENCIA
B112	EMERGENCY STOP, ARRÊT D'URGENCE, PARADA DE EMERGENCIA

*c (cont'd)*

Text	
Code	Description
M112	NOT AUS, ARRESTO EMERGENZA, ARRÊT D'URGENCE
D112	NOODSTOP
N112	NÖDSTOPP, EMERGENCY STOP
W112	NÖDSTOPP, EMERGENCY STOP
A112	NÖDSTOPP
L112	NEYÐARSTOPP, NEYÐARSTOPP
H112	NÖD-STOP, HÄTÄ-SEIS, NÖD-STOP

§ Sold only multiples of 10. Order (quantity of) 10 to receive one package of 10 pieces.

\* Must be used with base mount contact blocks and trim washer.

➤ Must be used with latch mounted contact blocks only.

**Legend Plates, Continued**

**Ordering Information\*\*§**

**Standard Text/Symbols**

1. Select the cat. no. for the appropriate legend size and color from the Selection Tables on this page.
2. Complete the cat. no. by adding the appropriate suffix no. selected from pages 61...63. Font size is automatically determined by the number of characters, as shown in the following table. Do not add the font code to the cat. no.

Font Size	No. of Characters		
	One-Piece Legend Plate	Two-Piece Legend Plate	Special Multi-Function Legend Plate
K (small)	>14	>13	>6
S (standard)	≤14	≤13	≤6

Example: **Cat. No. 800F-11WE101** identifies a white, 30 x 40 mm snap-in legend plate and frame with AUTO engraved on it.



**Custom Text (text not found on pages 61...63)**

1. Select the cat. no. for the appropriate legend size and color from the Selection Tables on this page.
2. Add **E100** followed by the font code (K, S, L) from the following table.

Font Size	Type of Legend Plate							
	One-Piece						Special Multi-Function	
	Max. No. of Lines			Max. No. of Lines			Max. Char. per Line	Max. No. of Lines
	Max. Char. per Line	30 x 40 mm	30 x 50 mm	Max. Char. per Line	30 x 40 mm	30 x 50 mm or 30 x 60 mm		
K (small)	16	2	5	15	2	5	7	3
S (standard)	14	2	3	13	1	3	6	3
L (large)	10	1	3	9	1	3	4	2

3. Complete the cat. no. by adding custom text to the order item's memo text or notes field.

Example: **Cat. No. 800F-12WE100K STARTER** identifies a white, 30 x 50 mm snap-in legend plate and frame with custom text STARTER engraved in small font.



**Selection Tables\***

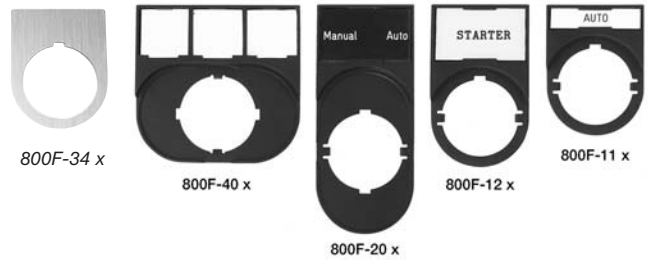

Type	Description	Cat. No. (Blank)	Cat. No. (with Text Symbols)
30 x 40 mm 2-piece snap-in plate and frame	Red with White Text	800F-11RE100	800F-11R□□□□
	White with Black Text	800F-11WE100	800F-11W□□□□
	Black with White Text	800F-11BE100	800F-11B□□□□
	Aluminum with Black Text	800F-11AE100	800F-11A□□□□
30 x 50 mm 2-piece snap-in plate and frame	White with Black Text	800F-12WE100	800F-12W□□□□
	Black with White Text	800F-12BE100	800F-12B□□□□
	Aluminum with Black Text	800F-12AE100	800F-12A□□□□
30 x 60 mm 2-piece snap-in plate and frame	White with Black Text	800F-20WE100	800F-20W□□□□
	Black with White Text	800F-20BE100	800F-20B□□□□
	Aluminum with Black Text	800F-20AE100	800F-20A□□□□
Special multi-function 4-piece snap-in plates and frame	White with Black Text	800F-40WE100	—
	Black with White Text	800F-40BE100	—
	Aluminum with Black Text	800F-40AE100	—
30 x 40 mm 1-piece	White with Black Text	800F-34WE100	800F-34W□□□□
	Black with White Text	800F-34BE100	800F-34B□□□□
	Aluminum with Black Text	800F-34AE100	800F-34A□□□□
30 x 50 mm 1-piece	Red with White Text	800F-35RE100	800F-35R□□□□
	White with Black Text	800F-35WE100	800F-35W□□□□
	Black with White Text	800F-35BE100	800F-35B□□□□
30 x 40 mm snap-in plate only	Aluminum with Black Text	800F-35AE100	800F-35A□□□□
	Red with White Text	800F-17RE100	800F-17R□□□□
	White with Black Text	800F-17WE100	800F-17W□□□□
30 x 50 mm snap-in plate only	Black with White Text	800F-17BE100	800F-17B□□□□
	Aluminum with Black Text	800F-17AE100	800F-17A□□□□
	White with Black Text	800F-18WE100	800F-18W□□□□
Special multi-function snap-in plate only‡	Black with White Text	800F-18BE100	800F-18B□□□□
	Aluminum with Black Text	800F-18AE100	800F-18A□□□□
	White with Black Text	800F-42WE100	800F-42W□□□□
	Black with White Text	800F-42BE100	800F-42B□□□□
	Aluminum with Black Text	800F-42AE100	800F-42A□□□□

Legend Plate Frame — 2-Piece Snap-In*			
Type	Cat. No.	Type	Cat. No.
30 x 40 mm	800F-110	30 x 60 mm	800F-200
30 x 50 mm	800F-120	Special multi-function	800F-400

\* Blank legend frames sold only in multiples of 10. Order (quantity of) 10 to receive one package of 10 pieces. Legends with standard text/symbols or custom text are packaged in quantities of 1.  
 † Font code **K** = 0.08 in; font code **S** = 0.10 in; font code **L** = 0.14 in.  
 ‡ Three snap-in plates are required for each legend frame.  
 § For configuration assistance, see RAISE product selection software.  
 \* Plate dimensions found on pages 66...67.

Bulletin 800F  
**22.5 mm Push Buttons**  
 Accessories, Continued

Custom Laser-Engraved Caps and Diffusers

Ordering Information\*\*§

Standard Text/Symbols

1. Select the cat. no. for the appropriate product and color from the Configurator Tables on this page.
2. Complete the cat. no. by adding the appropriate suffix no. selected from pages 61...63.

Example: **Cat. No. 800F-AF3CE166** identifies a flush, green cap with custom-engraved text ON.

3. Font size is automatically determined by the number of characters. ‡ Do not add a font code to the cat. no.

Font Size	No. of Characters
12 pt.	7
16 pt.	5...6
20 pt.	1...4

Custom Text (text not found on pages 61...63)

1. Select the cat. no. for the appropriate product and color from the Configurator Tables on this page.
2. Add E100 followed by the font code (G, H, J), based on the number of custom characters.
3. Complete the cat. no. by adding custom text to the order item's memo text or notes field.

Example: Cat. No. 800F-AF3CE100J FILL identifies a flush, green push button cap with custom laser-engraved text FILL in large font.

Font Size	No. of Characters	Max. No. of Lines
G (small) (12 pt.)	7	1
H (standard) (16 pt.)	5...6	1
J (large) (20 pt.)	1...4	1

Custom Symbols/Graphics (symbols not found on page 61)

1. Select the cat. no. for the appropriate product and color from the Configurator Tables on this page.
2. Add U100 to identify the custom symbol or graphic.
3. Please contact your local Allen-Bradley sales office to submit the graphic.

Example: **Cat. No. 800F-AD3CU100**

\* Package quantity of one for all laser-engraved caps and diffusers.  
 † Standard font is Arial Narrow.  
 ‡ Seven characters maximum allowable.  
 § For configuration assistance, see RAISE product selection software.

Configurator Tables

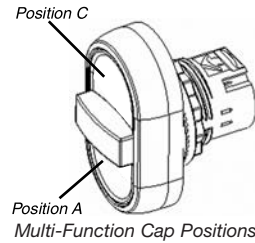

Push Button, Multi-Function Caps

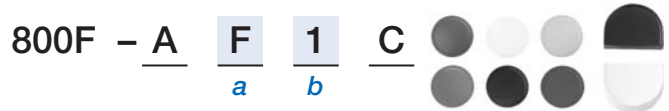

Type	
Code	Description
E	Push button extended cap
F	Push button flush cap
FA	Alternate action cap
FAU	Multi-function flush cap (for position A)
EAU	Multi-function extended cap (for position A)
FCU	Multi-function flush cap (for position C)
ECU	Multi-function extended cap (for position C)

Color	
Code	Description
0	Amber
1	White
2	Black
3	Green
4	Red
5	Yellow
6	Blue

Pilot Light Diffuser

800F - AD3C

Illuminated Push Button Diffusers

800F - AD2C (Flush or Alternate Action)

800F - AD4C (Extended and Guarded)



**Legend Texts**  
**Standard Symbols\***

Marking	Description	Std.	Suffix No.	Marking	Description	Std.	Suffix No.*§	Marking	Description	Std.	Suffix No.*§
(Blank)	Blank	—	U100		CONTINUOUS ROTATION TO LEFT	ISO 7B	U708		SETUP	DIN 986	U855
	START*‡§	ISO 71	U219		INTERRUPTED ROTATION TO LEFT	—	U710		COOLANT FLUID	ISO 101	U875
	—*‡§	ISO 72	U220		INTERRUPTED ROTATION TO RIGHT	—	U711		LIGHT	ISO 139, 102	U876
	START*‡§	ISO 5232	U221		DIRECTION OF SPINDLE SPEED	—	U717		WEIGHT	—	U877
	CONTINUOUS MOTION LEFT, RIGHT	—	U226		FEED	ISO 16	U720		REFILLING	DIN 256, ISO 104	U878
	CONTINUOUS MOTION UP, DOWN	—	U227		REDUCED SPEED	—	U723		FULL LEVEL	—	U879
O	STOP	—	U228		RAPID FEED	—	U724		DRAIN	DIN 257, ISO 106	U880
I	STEP 1	—	U229		NORMAL FEED	—	U725		OVERFLOW	DIN 258, ISO 105	U881
II	STEP 2	—	U230		LONGITUDINAL FEED	—	U726		OIL LUBRICATION	DIN 175, ISO 107	U882
O-I	STOP-START	—	U231		TRANSVERSE FEED	—	U727		BLOWING UNIT	DIN 263, ISO 108	U883
I-O	START-STOP	—	U232		RAPID TRANSVERSE	ISO 26	U728		SUCTION UNIT	DIN 264, ISO 109	U884
I-II	—	—	U233		THREADING	—	U729		STEPLESS OPERATION	ISO 61	U900
I-O-II	—	—	U234		INCREASE	ISO 28	U730		CLAMP OR TIGHTEN	ISO 63A	U901
—-O-I	—	—	U236		DECREASE	ISO 29	U731		CLAMP OR TIGHTEN	—	U902
	—	—	U237		CONVENTIONAL MILLING	—	U736		LOOSEN	ISO 64A	U903
I-II-III	—	—	U240		CLIMB MILLING	—	U737		LOOSEN	—	U904
	CONTINUOUS MOTION	—	U241		ELECTRIC MOTOR	ISO 41	U800		BRAKE ON	ISO 65	U905
	CONTINUOUS MOTION	—	U242		TURNING SPINDLE	—	U803		BRAKE RELEASE	ISO 66	U906
	CONTINUOUS MOTION	—	U243		DRILLING SPINDLE	—	U804		AUTO CYCLE	—	U907
III	STEP 3	—	U249		MILLING SPINDLE	—	U805		MANUAL	DIN 35	U908
O-—	—	—	U256		GRINDING SPINDLE	—	U806		START	ISO 69	U909
I-O-I	START-STOP-START	—	U282		PUMP	ISO 48	U807		STOP	ISO 70	U910
O-1-2	—	—	U285		COOLANT PUMP	—	U808		TAKE ACTION WHEN CONTROL IS OPERATING	—	U912
IV	STEP 4	—	U604		LUBRICATION PUMP	—	U809		ENGAGE	DIN 46, ISO 74	U913
V	STEP 5	—	U605		HYDRAULIC SYSTEMS PUMP	—	U810		DISENGAGE	DIN 45, ISO 75	U914
	CONTINUOUS MOTION	ISO 1	U700		HYDRAULIC MOTOR	—	U811		ENGAGE TRACE	—	U917
	LINEAR MOTION TWO DIRECTIONS	ISO 2	U701		TRACER	—	U812		DISENGAGE TRACE	—	U918
I	VERTICAL MOTION	—	U702		SHEAR PIN CONSTRUCTION	ISO 91	U850		CHANGE SPEED ONLY IN STOPPED POSITION	—	U919
	INTERRUPTED MOTION*§	—	U703		ATTENTION/DANGER	DIN 131, ISO 92	U851		CHANGE SPEED ONLY WHEN IN MOTION	—	U920
	LIMITED MOTION*§	ISO 4	U704		CAUTION	ISO 93	U852		CONTINUOUS ADJUSTMENT	ISO 62	U921
	LIMITED MOTION AND RETURN*§	ISO 5	U705		MAIN SWITCH	ISO 94	U853	—	AUTOMATIC OR SEMIAUTOMATIC CYCLE	DIN 267	U922
	OSCILLATING MOTION, CONTINUOUS CYCLE*§	—	U706		ACOUSTIC WARNING EQUIPMENT	DIN 155	U854	R	RESET	—	U924
	CONTINUOUS ROTATION TO RIGHT*§	DIN 100, ISO 7A	U707	—	—	—	—	—	—	—	—

\* Items in gray shaded table cells only available on legend plates. Not available as laser-engraved text on button caps, illuminated push button diffusers, or pilot light diffusers.

‡ Not available on -11 or -17 legend plates.

§ Not available on -34 legend plates.

➤ Not available on -42 legend plates.

‡ Not available on -12, -18, or -20 legend plates.

‡ Not available on -35 legend plates.

Bulletin 800F  
**22.5 mm Push Buttons**  
 Accessories, Continued

Legend Texts, Continued

Standard Text\*

English

Marking	Suffix No.	Marking	Suffix No.	Marking	Suffix No.	Marking	Suffix No.	Marking	Suffix No.
(Blank)	E100	FOR-OFF-REV➤	E261	LAST STOP	E278	PULL TO RESET	E176	START	E208
I-O-AUTO§*➤	E235	FOR-REV➤	E253	LEFT	E145	PUMP STOP	E290	START CYCLE	E209
ACCU-STOP➤	E284	FOR-STOP-REV➤	E254	LEFT-RIGHT➤	E146	PURGE	E271	START-JOG➤	E210
AT SPEED	E285	FORWARD	E120	LOCAL-REMOTE➤	E147	PUSH TO STOP	E179	START-STOP➤	E211
AUTO	E101	FORWARD-AUTO-REVERSE➤	E121	LOW	E148	PUSH TO STOP-TWIST OR PULL, RELEASE*§➤	E262	STOP	E212
AUTO-O-HAND§*➤	E250			LOW-HIGH➤	E149			STOP-CYCLE➤	E213
AUTO-HAND➤	E102	FORWARD-OFF-REVERSE➤	E122	LOW-OFF-HIGH➤	E150	PUSH-TO-TEST	E181	STOP-RESET➤	E214
AUTO-MAN-OFF➤	E103			LOW SPEED	E151	RAISE	E182	STOP-START➤	E215
AUTO-MANUAL➤	E286	FORWARD-STOP-REVERSE➤	E123	LOWER	E152	RAISE-LOWER➤	E183	SUMMER-OFF-WINTER➤	E216
AUTO-OFF-HAND➤	E104			LOW-OFF-RAISE➤	E153	RAISE-OFF-LOWER➤	E184		
BLOWER	E268	FORWARD-REVERSE➤	E124	LOWER-RAISE➤	E154	READY	E185	SUMMER-WINTER➤	E217
BRAKE	E105			MANUAL	E155	RESET	E186	SUPPLY ON	E218
BYPASS-OFF-DRIVE§*➤	E297	FULL SPEED	E125	MAN-O-AUTO§*➤	E238	RETURN	E187	TEST	E219
BYPASS ON§*➤	E295	HAND	E126	MAN-AUTO➤	E258	REV-FOR➤	E260	TRANSFER➤	E220
BYPASS START§*➤	E299	HAND-I-AUTO§*➤	E239	MANUAL-AUTO➤	E156	REVERSE	E188	TRIP	E221
BYPASS STOP§*➤	E298	HAND-O-AUTO➤	E283	MAN-OFF-AUTO➤	E259	REVERSE-FORWARD➤	E189	UNCLAMP	E222
CLAMP	E106	HAND-AUTO➤	E127	MANUAL-OFF-AUTO➤	E157			UP	E223
CLOSE	E107	HAND-OFF-AUTO➤	E128	MOTOR RUN	E158	REVERSE-OFF-FORWARD➤	E190	UP-DOWN➤	E224
CYCLE START	E108	HAND OFF	E264	MOTOR RUNNING	E159			UP-OFF-DOWN➤	E225
DECREASE➤	E109	HAND ON	E263	MOTOR START	E160	RIGHT	E191		
DRIVE-START➤	E287	HAND START	E265	MOTOR STOP	E161	RIGHT-LEFT➤	E192		
DRIVE-STOP➤	E288	HAND STOP	E266	MOTOR STOPPED	E162	ROTATE CW	E246		
DOWN	E110	HEAT	E270	NO FLIP	E275	ROTATE CCW	E247		
DOWN-OFF-UP➤	E111	HIGH	E129	OFF	E163	RUN	E193		
DRIVE ON§*➤	E296	HIGH-LOW➤	E130	OFF CIRCUIT	E244	RUN-JOG➤	E194		
EMERG STOP	E251	HIGH-OFF-LOW➤	E131	OFF-COOLANT-ON➤	E164	RUN-SAFE-JOG➤	E195		
EMERGENCY➤	E248	IN	E132	OFF-LIGHT-ON➤	E272	RUNNING	E243		
EMERGENCY OFF➤	E294	IN-OUT➤	E133	OFF-ON➤	E165	SAFE	E196		
EMERGENCY STOP➤	E112	INCH	E134	ON	E166	SAFE-RUN➤	E197		
ENABLE	E279	INCH-REV➤	E257	ON CIRCUIT	E245	SETUP	E198		
ENTER	E277	INCH-REVERSE➤	E135	ON-OFF➤	E167	SETUP-RUN➤	E302		
ERROR	E273	INCH-RUN➤	E136	ON-OFF-AUTO➤	E168	SETUP-SERVICE➤	E199		
EXHAUSTER➤	E269	INCREASE➤	E137	ON-STOP-SAFE➤	E169	SEQUENCE-TEST➤	E200		
FAULT	E113	INSPECT	E274	OPEN	E170	SLOW	E201		
FAST	E114	JOG	E138	OPEN-CLOSE➤	E171	SLOWER	E202		
FAST-OFF-SLOW➤	E289	JOG-FOR➤	E255	OPEN-OFF-CLOSE➤	E172	SLOWEST	E203		
FASTER	E115	JOG-FORWARD➤	E139	OUT	E173	SLOW-FAST➤	E204		
FEED START	E116	JOG-OFF-RUN➤	E140	OVERLOAD➤	E267	SLOW-OFF-FAST➤	E205		
FEED STOP	E117	JOG-REV➤	E256	OVERLOAD TRIP➤	E174	SLOW-STOP-FAST➤	E206		
FEEDER OFF	E118	JOG-REVERSE➤	E141	OVERLOAD RESET➤	E175	SLOW-OFF-START➤	E207		
FEEDER ON	E119	JOG-RUN➤	E142	POWER OFF	E177	SLOW SPEED	E291		
FIFO	E276	JOG-SAFE-RUN➤	E143	POWER ON	E178	SOFT STOP	E292		
FOR-AUTO-REV➤	E252	JOG-STOP-RUN➤	E144	PULL TO START	E180	SPEED	E293		

\* Items in gray shaded table cells only available on legend plates. Not available as laser-engraved text on button caps, illuminated push button diffusers, or pilot light diffusers.

§ Not available on -11 or -17 legend plates.

§ Not available on -34 legend plates.

\* Not available on -35 legend plates.

➤ Not available on -42 legend plates.

Legend Texts, Continued

Standard Text, Continued\*

French

Marking	Suffix No.	Marking	Suffix No.	Marking	Suffix No.	Marking	Suffix No.	Marking	Suffix No.
A-COUPS	F138	AVANT-ARRÊT-ARRIÈRE➤	F122	DESCENDRE➤	F110	HORS MANUEL	F249	MARCHE-ARRÊT➤	F211
ACCU-STOP➤	F280			DROIT	F191	LENT	F201	MONTER	F182
ARRIÈRE	F188	AVANT-ARRIÈRE➤	F124	EN	F247	LENT-ARRÊT-VITE➤	F205	OUVRIER	F170
ARRÊT	F163	AV-ARR➤	F290	EN CIRCUIT	F245	M FORCEE	F284	PANNE	F113
ARRÊT D'ENTR	F289	AV-HORS-ARR➤	F253	EN MANUEL	F250	MANUEL	F126	RAP-HORS-LENT➤	F285
ARRÊT DOUX	F288	BAS	F148	FERMER	F107	MANUEL-ARRÊT-AUTO➤	F128	RAPIDE	F114
ARRÊT D'URGENCE➤	F112	BAS-ARRÊT-HAUT➤	F150	FREINAGE➤	F105			RÉGLER	F198
ARRÊT-MANUEL	F251	DEMAR. D-ENTR	F283	GAUCHE	F145	MANUEL-AUTO➤	F127	SURCHARGE➤	F254
ARRÊT-MARCHE➤	F165	DEMAR.-MAN.	F252	HAUT	F129	MANUEL-HORS-AUTO➤	F157	VARIATEUR ALIMENTÉ§♣➤	F293
ARRÊT POMPE	F286	DÉRIV-ARRÊT-EFN§♣➤	F294	HAUT-HORS-BAS➤	F131			VIT. ATTEINT	F281
AUTO	F101	DÉRIV ARRÊT§♣➤	F295	HORS	F246	MARCHE	F166	VIT. LENTE	F287
AUTO-MANUEL➤	F282	DÉRIV MARCHES§♣➤	F296	HORS CIRCUIT	F244	—	—	VITESSE	F291
AVANT	F120	DÉRIVATION ALIMENTÉ§♣➤	F292	HORS-EN➤	F248	—	—	—	—

Spanish

Marking	Suffix No.	Marking	Suffix No.	Marking	Suffix No.	Marking	Suffix No.	Marking	Suffix No.
ABRIR	S170	ARRANQÉ	S166	DERECHA	S191	MARCHA	S208	PARADA-MARCHA➤	S165
ADELANTE➤	S120	ATRÁS	S188	EN SERVICIO➤	S243	MARCHA-PARADA➤	S211	PARO	S163
ADELANTE-ATRÁS➤	S124	BAJADA	S152	IZQUIERDA➤	S145	PARADA	S212	SUBIDA	S182
ADELANTE-PARADA-ATRÁS➤	S123	BAJAR	S110	MANUAL	S126	PARADA DE EMERGENCIA➤	S112	SUBRIR	S223
		CERRAR	S107	MANUAL-AUTO➤	S127			—	—

German

Marking	Suffix No.	Marking	Suffix No.	Marking	Suffix No.	Marking	Suffix No.	Marking	Suffix No.
AB	G110	EINRICHTEN➤	G198	LANGSAM	G201	ÖFFNEN	G170	VOR	G120
AUF	G223	HAND	G126	LINKS	G145	RECHTS	G191	VOR-AUS-ZURÜCK➤	G122
AUS	G163	HAND-AUS-AUTO➤	G128	LINKS-RECHTS➤	G146	SCHNELL	G114	VOR-ZURÜCK➤	G124
AUS-EIN➤	G165	HAND-AUTO➤	G127	NIEDRIG	G148	SENKEN	G152	ZU	G107
BETRIEB	G243	HEBEN	G182	NIEDRIG-AUS-HOCH➤	G150	STÖRUNG	G113	ZURÜCK	G188
EIN	G166	HOCH	G129	NOT AUS	G112	—	—	—	—

Italian

Marking	Suffix No.	Marking	Suffix No.	Marking	Suffix No.	Marking	Suffix No.	Marking	Suffix No.
ABBASSARE➤	T152	AVANTI-DISINS-INDIETRO➤	T122	DISCESA	T110	IN SERVIZIO➤	T243	MARCIA-ARRESTO➤	T211
ALTO	T129			DISINS-INS➤	T165	LENTO	T201	PREPARARE➤	T198
APRIRE	T223	AVANTI-INDIETRO➤	T124	DISINSERITO➤	T163	MANUALE	T126	RAPIDO	T114
ARRESTO	T212	BASSO	T148	DISTURBO➤	T113	MANUALE-AUTO➤	T127	ROTAZIONE CW➤	T246
ARRESTO EMERGENZA➤	T112	BASSO-DISINS-ALTO➤	T150	EMERGENZA➤	T248	MANUALE-DISINS-AUTO➤	T128	ROTAZIONE CCW➤	T247
		DESTRA	T191	INDIETRO➤	T188			SALITA	T182
AUTOMATICO➤	T101	CHIUDERE➤	T107	INSERITO➤	T166	MARCIA	T208	SINISTRA➤	T145
AVANTI	T120	—	—	—	—	—	—	—	—

Swedish

Marking	Suffix No.	Marking	Suffix No.	Marking	Suffix No.	Marking	Suffix No.	Marking	Suffix No.
BACK	N188	HÖGER	N191	NERN	110	UPP	N223	VÄNSTER	N145
FRAM	N120	—	—	—	—	—	—	—	—

\* Items in gray shaded table cells only available on legend plates. Not available as laser-engraved text on button caps, illuminated push button diffusers, or pilot light diffusers.

§ Not available on -34 legend plates.

♣ Not available on -35 legend plates.

➤ Not available on -42 legend plates.

# 22.5 mm Push Buttons

## Approximate Dimensions

Dimensions in millimeters. Dimensions are not intended to be used for manufacturing purposes. Refer to RAISE software for additional dimensional information.

### Panel Hole Spacing

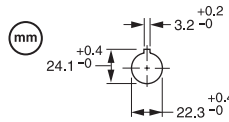

	40	50	40	50	40/60	50/60			
	30		48		40/60		60/90		
								70	50
								30	50
									40
									50

### Non-Illuminated and Illuminated Momentary Flush Push Button Operators

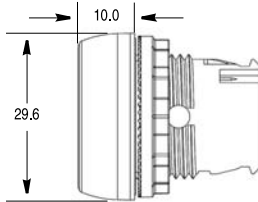

### Illuminated and Non-Illuminated Momentary Extended Push Button Operators

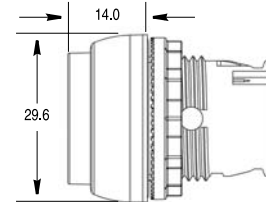

### Non-Illuminated Guarded, Illuminated and Non-Illuminated Alternate Action Push Button Operators

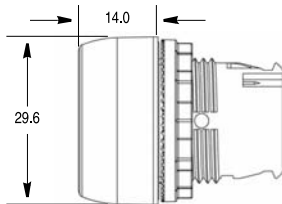

### Illuminated Momentary Guarded Push Button Operators

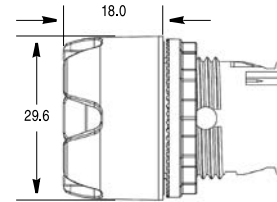

### Illuminated and Non-Illuminated Momentary Mushroom Operators 40 mm and 60 mm

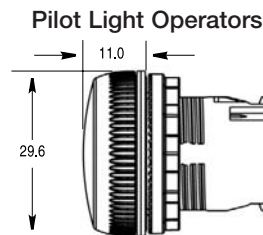
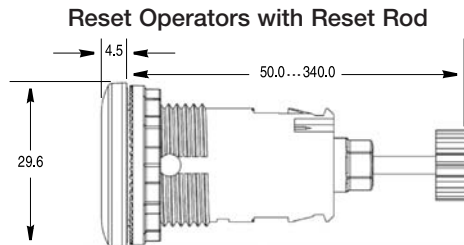
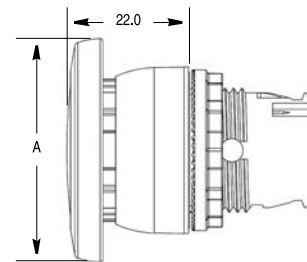

Operator	A
40 mm	39.8
60 mm	59.8



Dimensions in millimeters. Dimensions are not intended to be used for manufacturing purposes.

**Illuminated and Non-Illuminated  
 2-Position Multi-Function Operators**

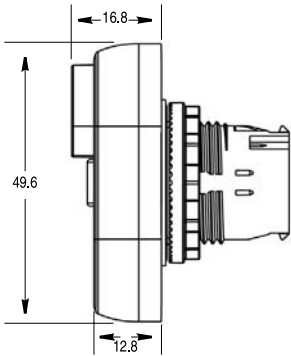

**Illuminated and Non-Illuminated  
 Knob Selector Switch and  
 Potentiometer Operators**

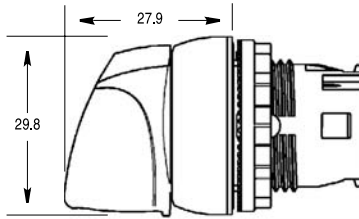

**Non-Illuminated Knob Lever Selector  
 Switch Operators**

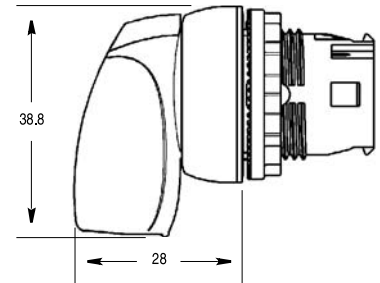

**Non-Illuminated 3-Position  
 Multi-Function Operators**

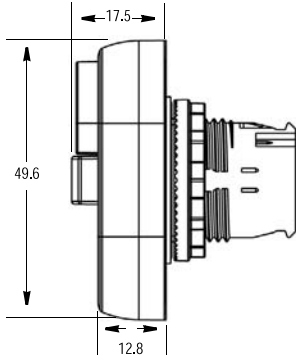

**Illuminated and Non-Illuminated  
 Push-Pull Mushroom Operators  
 30 mm, 40 mm, and 60 mm**

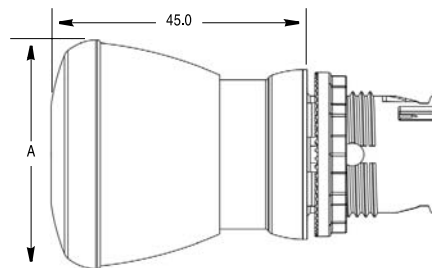

Operator	A
30 mm	30.0
40 mm	40.0
60 mm	60.0

**Illuminated and Non-Illuminated  
 Twist-to-Release Operators  
 30 mm, 40 mm, and 60 mm**

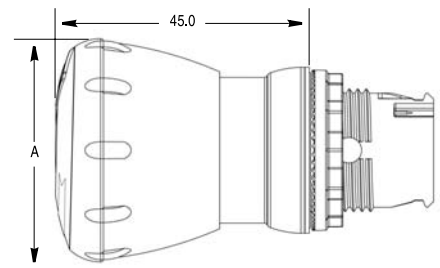

Operator	A
30 mm	30.0
40 mm	40.0
60 mm	60.0

**Mushroom Key Release Operator 40 mm**

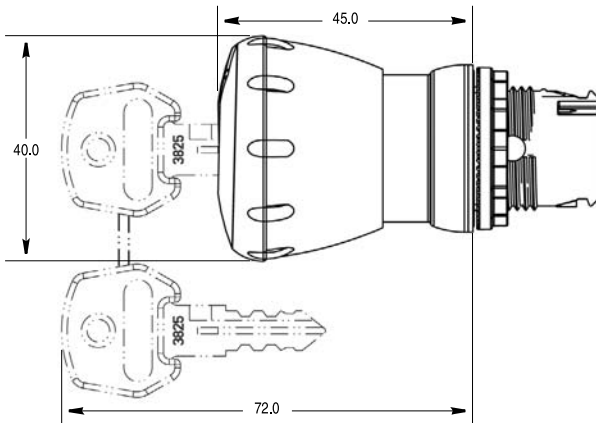

**Key Selector Switch and Key Ejected  
 SensEject Operators**

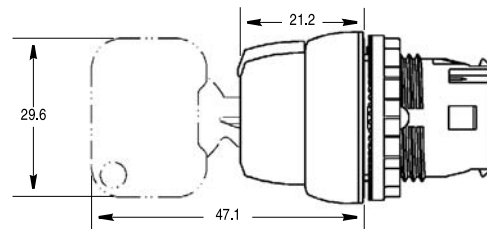

**Toggle Switch Operators**

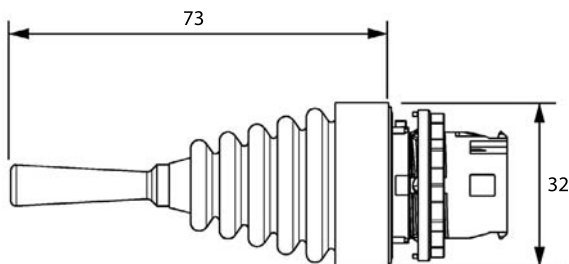

**Selector Jog Operators**

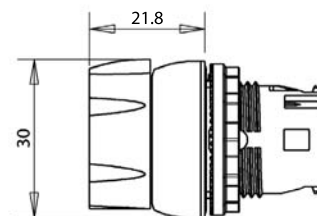

## 22.5 mm Push Buttons

### Approximate Dimensions, Continued

Dimensions in millimeters. Dimensions are not intended to be used for manufacturing purposes.

Back-of-Panel Components —  
Incandescent Module with Latch

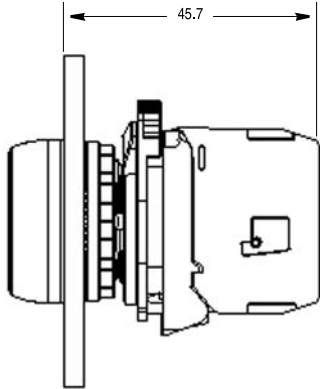

Back-of-Panel Components —  
LED Module with Latch

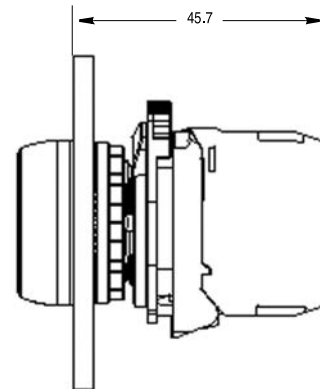

Back-of-Panel Components —  
Contact Cartridges with Latch

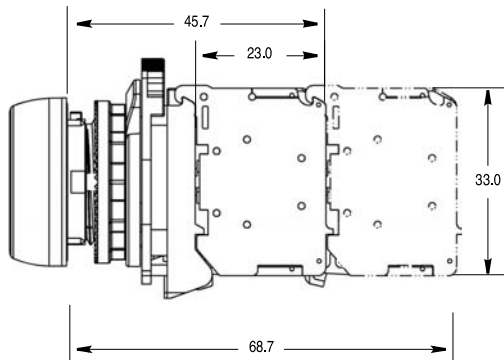

Back-of-Panel Components —  
Dual Circuit Contact Block or  
Self Monitoring Contact Block  
(Max. of 1 Deep)

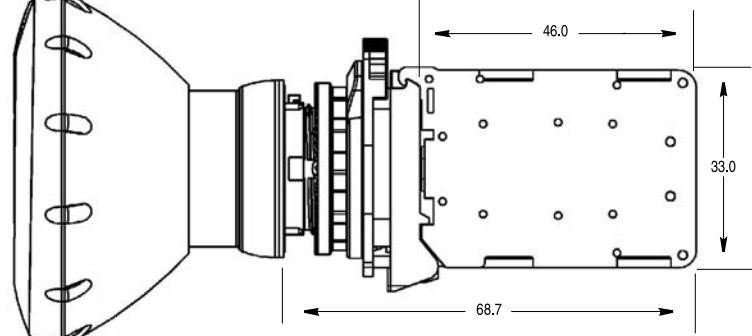

Potentiometer with Resistive Element

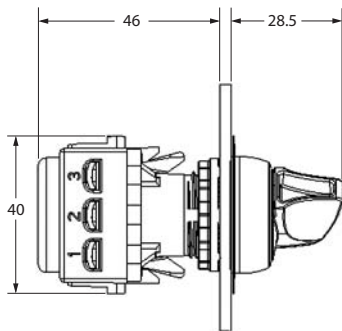

30 x 40 mm Snap-In Legend Plate

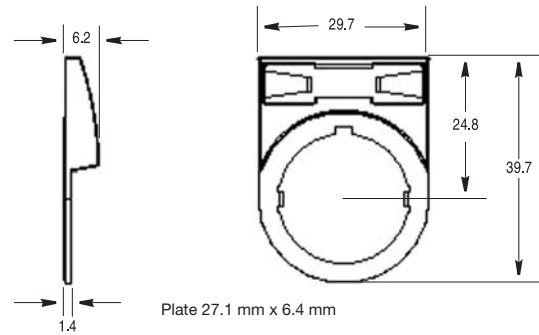

Protective Ring

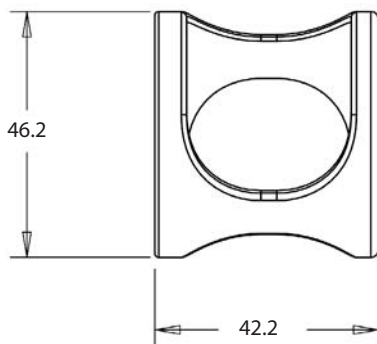

30 x 50 mm Snap-In Legend Plate

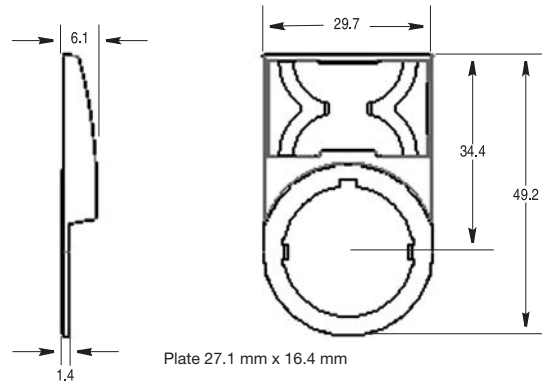

Dimensions in millimeters. Dimensions are not intended to be used for manufacturing purposes.

**Plastic Guard**

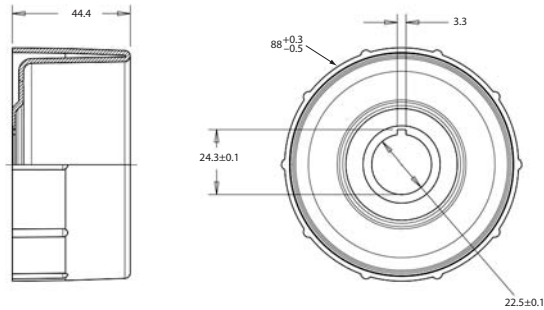

**30 x 60 mm Snap-In Legend Plate**

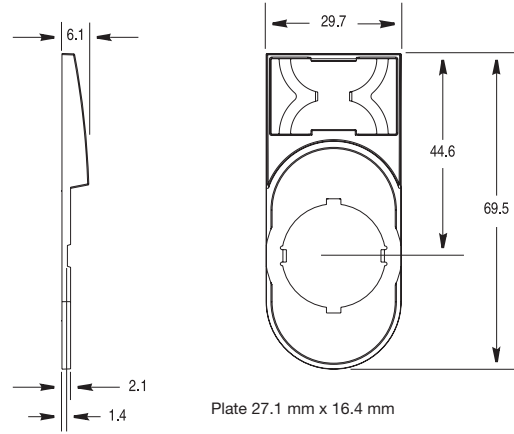

**60 mm Round Legend**

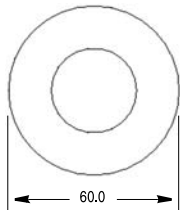

**Potentiometer Legend Plate**

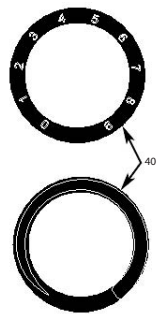

**90 mm Round Legend**

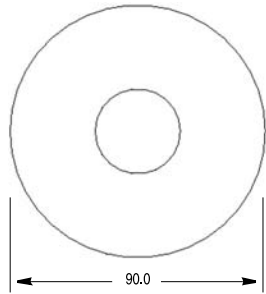

**Special Multi-Function Snap-In Legend Plate**

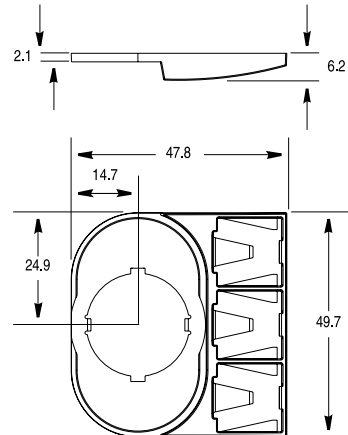

**30 x 40 mm One-Piece Legend Plate**

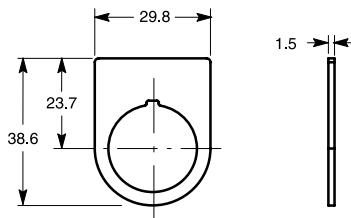

**30 x 50 mm One-Piece Legend Plate**

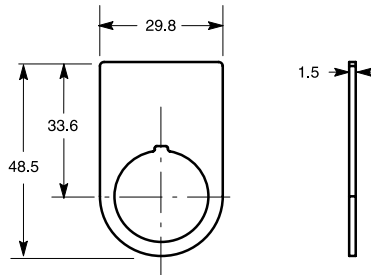

**30 mm to 22.5 mm Hole Adapter**

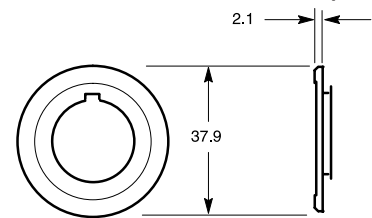

**Trim Washer**

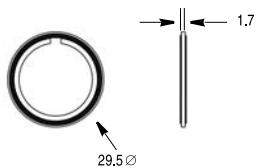

**Hole Plug**

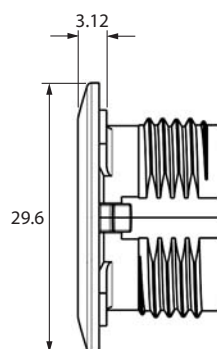

**Base Mount Adapter**

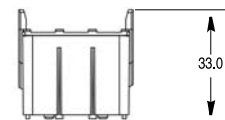

**Anti-Rotation Washer**

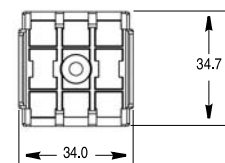
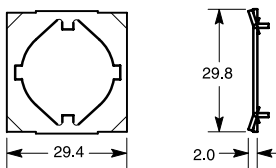

Note: Panel thickness range is 1.0...6.0 mm maximum.  
 Panel thickness reduced to 4.5 when optional legend plates are used.

# 22.5 mm Push Buttons

## Approximate Dimensions, Continued

Dimensions in millimeters. Dimensions are not intended to be used for manufacturing purposes.

Locking Cover

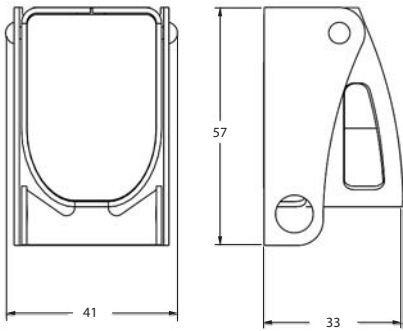

Maintained Mushroom Locking Attachment

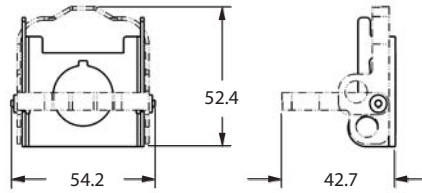

Momentary Mushroom Locking Attachment

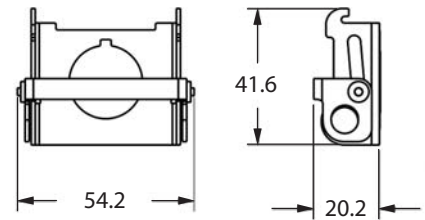

Extended Non-Illuminated Locking Attachment

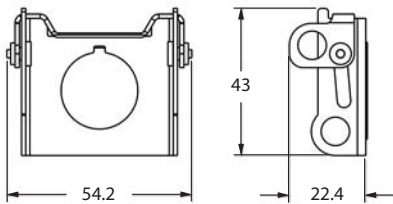

Flush Non-Illuminated Locking Attachment

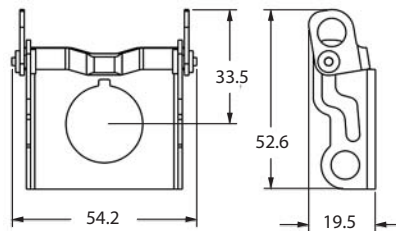

Selector Switch Locking Cover  
(Same for all Lock Positions)

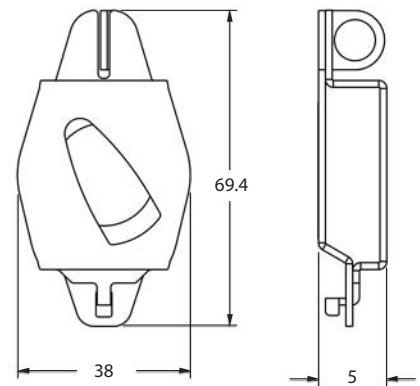

Narrow Guard

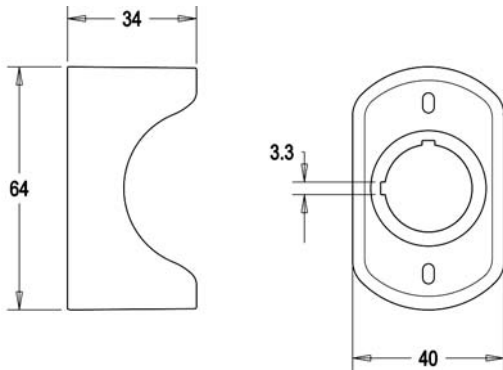



Dimensions in millimeters. Dimensions are not intended to be used for manufacturing purposes.

**Plastic Enclosures** ❄️

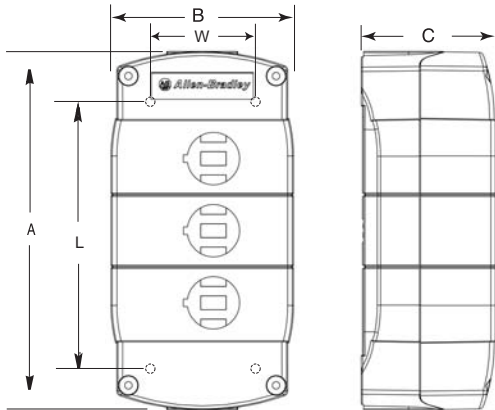

**Metal Enclosures**

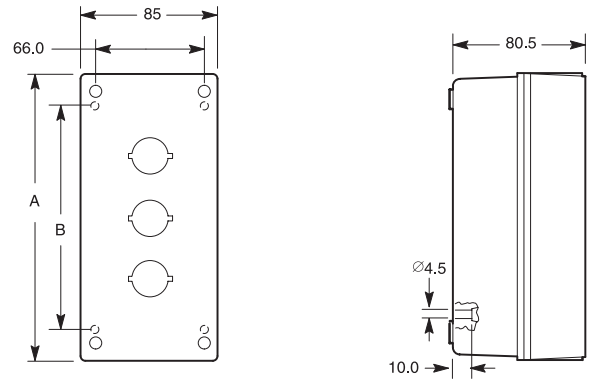

Cat. No.	No. of Units (Holes)	A	B	C	Mounting Holes	
					W	L
800F-1P*	1	85	89	58	58	59
800F-2P*	2	124	79	58	48	102.5
800F-3P*	3	155	79	58	48	133
800F-4P*	4	186	79	58	48	164.5
800F-6P*	6	248	87	64	55	224

Cat. No.	No. of Units (Holes)	A	B
800F-1M*	1	99	62
800F-2M*	2	137	100
800F-3M*	3	174	137
800F-5M*	5	249	212

\* P = PG conduit holes or M = Metric conduit holes  
 ❄️ Mounting screw head diameter = 7 mm max. for 1P enclosures

**Pendant Stations**

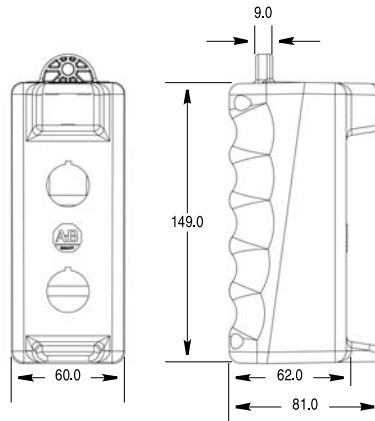





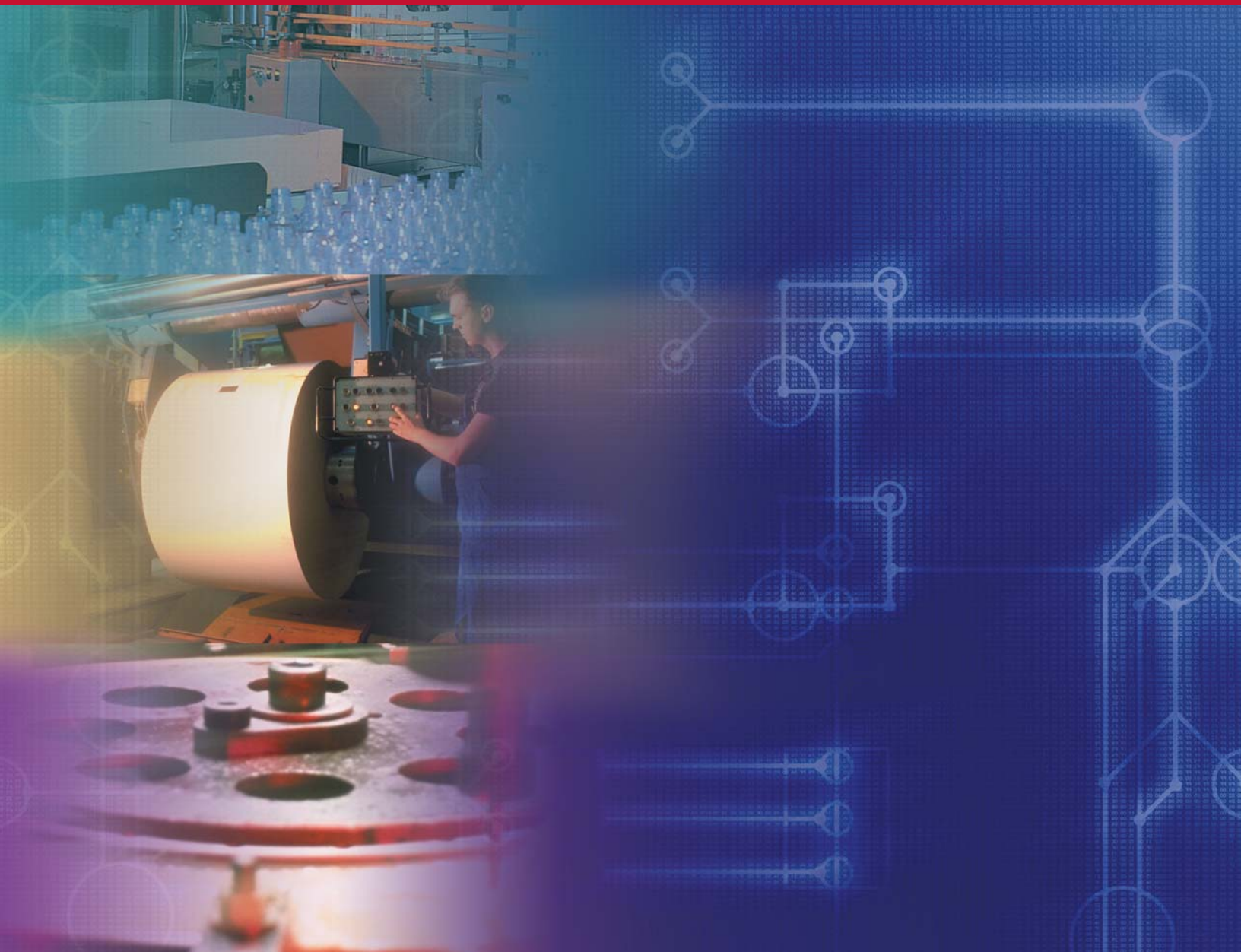

**[www.rockwellautomation.com](http://www.rockwellautomation.com)**

---

**Power, Control and Information Solutions Headquarters**

Americas: Rockwell Automation, 1201 South Second Street, Milwaukee, WI 53204 USA, Tel: (1) 414.382.2000, Fax: (1) 414.382.4444

Europe/Middle East/Africa: Rockwell Automation, Vorstlaan/Boulevard du Souverain 36, 1170 Brussels, Belgium, Tel: (32) 2 663 0600, Fax: (32) 2 663 0640

Asia Pacific: Rockwell Automation, Level 14, Core F, Cyberport 3, 100 Cyberport Road, Hong Kong, Tel: (852) 2887 4788, Fax: (852) 2508 1846

Publication 800F-SG001E-EN-P — February 2007

Copyright © 2007 Rockwell Automation, Inc. All rights reserved. Printed in USA.

Supersedes Publication 800F-SG001D-EN-P — June 2006