

BASIC M8

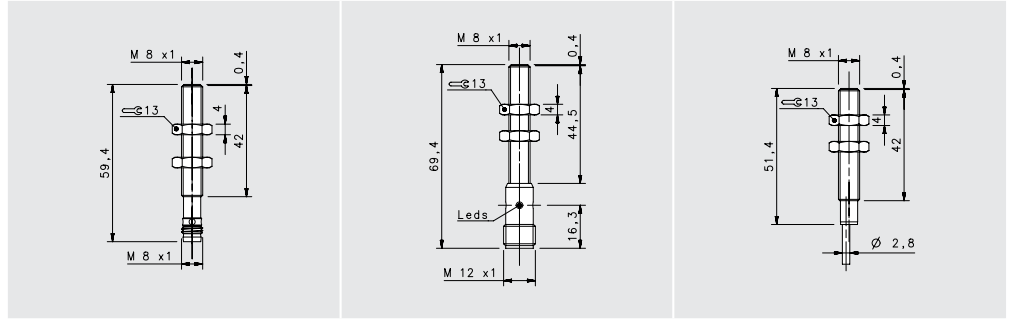

STANDARD

FLUSH

NOMINAL SWITCHING DISTANCE				M8 conn	M12 conn	cable
				1,5 mm	1,5 mm	1,5 mm
10-30 Vdc	PNP/NPN NO-NC	4 wires	order No.	---	---	---
10-30 Vdc	PNP NO	3 wires	order No.	IS-08-A1-S1 95B061141	IS-08-A1-S2 95B061131	IS-08-A1-03 95B061121
10-30 Vdc	PNP NC	3 wires	order No.	IS-08-A2-S1 95B061171	IS-08-A2-S2 95B061161	IS-08-A2-03 95B061151
10-30 Vdc	NPN NO	3 wires	order No.	IS-08-A3-S1 95B061081	IS-08-A3-S2 95B061071	IS-08-A3-03 95B061061
10-30 Vdc	NPN NC	3 wires	order No.	IS-08-A4-S1 95B061111	IS-08-A4-S2 95B061101	IS-08-A4-03 95B061091
10-30 Vdc	PNP NO-NC	4 wires	order No.	---	---	---
10-30 Vdc	NPN NO-NC	4 wires	order No.	---	---	---
10-30 Vdc	NO-NC	2 wires	order No.	---	---	---
20-250 Vac/Vdc	NO	2 wires	order No.	---	---	---
20-250 Vac/Vdc	NC	2 wires	order No.	---	---	---
20-250 Vac	NO	2/3 wires	order No.	---	---	---
10-30 Vdc	Analog 0-20 mA	3 wires	order No.	---	---	---
NAMUR amplifier	NAMUR	2 wires	order No.	---	---	---

	10-30 Vdc (-15/10%)	10-30 Vdc (-15/10%)	10-30 Vdc (-15/10%)
Nominal Voltage	10-30 Vdc (-15/10%)	10-30 Vdc (-15/10%)	10-30 Vdc (-15/10%)
Residual Ripple	< 10%	< 10%	< 10%
Hysteresis	< 10%	< 10%	< 10%
Max. Output Current	200mA	200mA	200mA
Min. Output Current	---	---	---
Residual Current	< 10 mA	< 10 mA	< 10 mA
Voltage Drop	< 1,2 V (I=100mA)	< 1,2 V (I=100mA)	< 1,2 V (I=100mA)
Operation Led	Yellow	Yellow	Yellow
Switching Frequency	1000 Hz	1000 Hz	1000 Hz
Start Up Delay	< 50 ms	< 50 ms	< 50 ms
Repeatability	< 3%	< 3%	< 3%
Short Circuit Protection	Present (self-resetting)	Present (self-resetting)	Present (self-resetting)
Electric Protection	Against polarity reversal inductive loads	Against polarity reversal inductive loads	Against polarity reversal inductive loads
Temperature Limit	(-25 ... +70 °C)	(-25 ... +70 °C)	(-25 ... +70 °C)
Protection Degree	IP67	IP67	IP67
Cable Length	---	---	2 m
Cable Section	---	---	3x 0,14 mm ²
Housing Material	Nickel-plated brass	Nickel-plated brass	Nickel-plated brass
Weight - Cable Output	---	---	80 g
Weight - Connector Output	35g	55g	---

BASIC M8

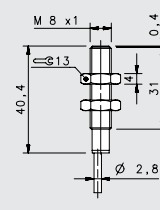
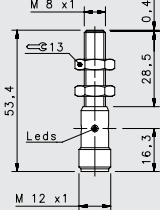
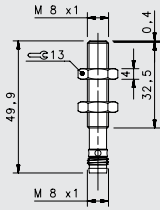

SHORT

FLUSH

NOMINAL SWITCHING DISTANCE

				M8 conn	M12 conn	cable
				1,5 mm	1,5 mm	1,5 mm
10-30 Vdc	PNP/NPN NO-NC	4 wires	order No.	---	---	---
10-30 Vdc	PNP NO	3 wires	order No.	IS-08-B1-S1 95B066860	IS-08-B1-S2 95B066590	IS-08-B1-03 95B061921
10-30 Vdc	PNP NC	3 wires	order No.	IS-08-B2-S1 95B066890	IS-08-B2-S2 95B066620	IS-08-B2-03 95B061951
10-30 Vdc	NPN NO	3 wires	order No.	IS-08-B3-S1 95B066810	IS-08-B3-S2 95B066530	IS-08-B3-03 95B061861
10-30 Vdc	NPN NC	3 wires	order No.	IS-08-B4-S1 95B066830	IS-08-B4-S2 95B066560	IS-08-B4-03 95B061891
10-30 Vdc	PNP NO-NC	4 wires	order No.	---	---	---
10-30 Vdc	NPN NO-NC	4 wires	order No.	---	---	---
10-30 Vdc	NO-NC	2 wires	order No.	---	---	---
20-250 Vac/Vdc	NO	2 wires	order No.	---	---	---
20-250 Vac/Vdc	NC	2 wires	order No.	---	---	---
20-250 Vac	NO	2/3 wires	order No.	---	---	---
10-30 Vdc	Analog 0-20 mA	3 wires	order No.	---	---	---
NAMUR amplifier	NAMUR	2 wires	order No.	---	---	---

	10-30 Vdc (-15/10%)	10-30 Vdc (-15/10%)	10-30 Vdc (-15/10%)
Nominal Voltage	10-30 Vdc (-15/10%)	10-30 Vdc (-15/10%)	10-30 Vdc (-15/10%)
Residual Ripple	< 10%	< 10%	< 10%
Hysteresis	< 10%	< 10%	< 10%
Max. Output Current	200mA	200mA	200mA
Min. Output Current	---	---	---
Residual Current	< 10 mA	< 10 mA	< 10 mA
Voltage Drop	< 1,2 V (I=100mA)	< 1,2 V (I=100mA)	< 1,2 V (I=100mA)
Operation Led	Yellow	Yellow	Yellow
Switching Frequency	1000 Hz	1000 Hz	1000 Hz
Start Up Delay	< 50 ms	< 50 ms	< 50 ms
Repeatability	< 3%	< 3%	< 3%
Short Circuit Protection	Present (self-resetting)	Present (self-resetting)	Present (self-resetting)
Electric Protection	Against polarity reversal inductive loads	Against polarity reversal inductive loads	Against polarity reversal inductive loads
Temperature Limit	(-25 ... +70 °C)	(-25 ... +70 °C)	(-25 ... +70 °C)
Protection Degree	IP67	IP67	IP67
Cable Length	---	---	2 m
Cable Section	---	---	3x 0,14 mm ²
Housing Material	Nickel-plated brass	Nickel-plated brass	Nickel-plated brass
Weight - Cable Output	---	---	80 g
Weight - Connector Output	35g	55g	---

BASIC M8

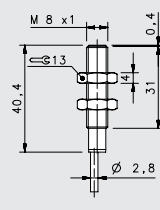
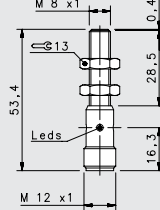
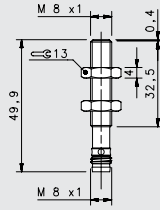

SHORT X2

FLUSH

NOMINAL SWITCHING DISTANCE

				M8 conn	M12 conn	cable
				2 mm	2 mm	2 mm
10-30 Vdc	PNP/NPN NO-NC	4 wires	order No.	---	---	---
10-30 Vdc	PNP NO	3 wires	order No.	IS-08-G1-S1 95B066850	IS-08-G1-S2 95B066580	IS-08-G1-O3 95B066370
10-30 Vdc	PNP NC	3 wires	order No.	IS-08-G2-S1 95B066880	IS-08-G2-S2 95B066610	IS-08-G2-O3 95B066390
10-30 Vdc	NPN NO	3 wires	order No.	IS-08-G3-S1 95B066800	IS-08-G3-S2 95B066520	IS-08-G3-O3 95B066330
10-30 Vdc	NPN NC	3 wires	order No.	IS-08-G4-S1 95B063131	IS-08-G4-S2 95B066550	IS-08-G4-O3 95B066350
10-30 Vdc	PNP NO-NC	4 wires	order No.	---	---	---
10-30 Vdc	NPN NO-NC	4 wires	order No.	---	---	---
10-30 Vdc	NO-NC	2 wires	order No.	---	---	---
20-250 Vac/Vdc	NO	2 wires	order No.	---	---	---
20-250 Vac/Vdc	NC	2 wires	order No.	---	---	---
20-250 Vac	NO	2/3 wires	order No.	---	---	---
10-30 Vdc	Analog 0-20 mA	3 wires	order No.	---	---	---
NAMUR amplifier	NAMUR	2 wires	order No.	---	---	---

	10-30 Vdc (-15/10%)	10-30 Vdc (-15/10%)	10-30 Vdc (-15/10%)
Nominal Voltage	10-30 Vdc (-15/10%)	10-30 Vdc (-15/10%)	10-30 Vdc (-15/10%)
Residual Ripple	< 10%	< 10%	< 10%
Hysteresis	< 10%	< 10%	< 10%
Max. Output Current	200mA	200mA	200mA
Min. Output Current	---	---	---
Residual Current	< 10 mA	< 10 mA	< 10 mA
Voltage Drop	< 1,2 V (I=100mA)	< 1,2 V (I=100mA)	< 1,2 V (I=100mA)
Operation Led	Yellow	Yellow	Yellow
Switching Frequency	500 Hz	500 Hz	500 Hz
Start Up Delay	< 75 ms	< 75 ms	< 75 ms
Repeatability	< 3%	< 3%	< 3%
Short Circuit Protection	Present (self-resetting)	Present (self-resetting)	Present (self-resetting)
Electric Protection	Against polarity reversal inductive loads	Against polarity reversal inductive loads	Against polarity reversal inductive loads
Temperature Limit	(-25 ... +60 °C)	(-25 ... +60 °C)	(-25 ... +70 °C)
Protection Degree	IP67	IP67	IP67
Cable Length	---	---	2 m
Cable Section	---	---	3 x 0,14 mm ²
Housing Material	Nickel-plated brass	Nickel-plated brass	Nickel-plated brass
Weight - Cable Output	---	---	80 g
Weight - Connector Output	35g	55g	---

